

12W 1CH BLE NFC Enabled LED Driver(Constant Current)

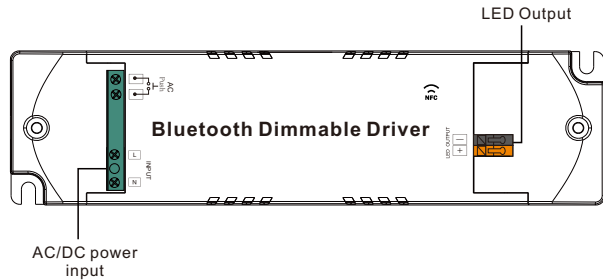

Important: Read All Instructions Prior to Installation

Function introduction



Product Data

Output	LED Channel	1
	DC Voltage	6-42V, Max. 50V
	Current	100-700mA via NFC tool; Min.current gear lower to 0.1mA, default 300mA
	Current Accuracy	±3% (±1% @ Certain full load) @ full load
	Rated Power	Max. 12W
Input	Voltage Range	220-240VAC/220-240VDC
	Absolute Voltage Range	196-264VAC/196-264VDC
	Frequency Range	0/50/60Hz
	Power Factor (Typ.)	> 0.95 @ 230VAC Full load
	Total Harmonic Distortion	THD ≤ 15% (@ full load / 230VAC)
	Efficiency (Typ.)	> 75% @ 230VAC full load
	AC Current (Typ.)	0.1A Max.
	Inrush Current (Typ.)	Max. 3.96A at 230VAC; 80µs duration
	Leakage Current	< 5mA /230VAC
Control	Anti Surge	L-N:2KV
	Dimming Interface	Bluetooth® Mesh(BLE 5.2)
	Dimming Range	0.01%-100% @ Max current
	Dimming Method	Amplitude/CCR dimming
	Dimming Curve	Linear/ Logarithmic optional

Protection	Short Circuit	Yes, remove the fault conditions and re-power the device
	Over Current	Yes, remove the fault conditions and re-power the device
	Over Temperature	Yes, remove the fault conditions and re-power the device
Environment	Working Temp.	-25°C ~ +45°C
	Max. Case Temp.	TC=85°C (Ta= "45°C")
	Working Humidity	10% ~ 95% RH non-condensing
	Storage Temp. & Humidity	-40°C ~ +80°C, 10% ~ 95% RH
Safety & EMC	Safety Standards	EN61347-1, EN61347-2-13
	Withstand Voltage	I/P-O/P: 3.75KVAC
	Isolation Resistance	I/P-O/P: 100M Ohms / 500VDC / 25°C / 70% RH
	EMC Emission	En55015, EN61000-3-2, EN61000-3-3
	EMC Immunity	En61547, EN61000-4-2,3,4,5,6,8,11
Others	MTBF	191350H, MIL-HDBK-217F @ 230VAC full load and 25°C ambient temperature
	Dimension	135x35x20mm (L*W*H)
	Warranty	5 Years

- Bluetooth NFC driver, Bluetooth® mesh network
- Dimmable LED driver. Max. output power 12W
- 100-700mA current selectable via NFC program tool. Min.current gear lower to 0.1mA
- Dimming curve/Power on state/Soft start/Soft off via NFC program tool.
- Class II power supply, full isolated plastic case
- High power factor and efficiency
- PUSH DIM function enabled
- To switch and dim LED lighting luminaries
- Amplitude/CCR dimming, smooth and deep dimming
- Mesh network, which has a much longer control distance, transmits received signals to neighboring devices
- Supporting our kinetic energy switches and EnOcean switches EWSSB and EWSDB
- In typical indoor environment, the typical range for wireless communication is 20m to 25m . Actual range is dependent on field installation.
- On-board antenna
- Waterproof grade: IP20
- 5 years warranty

Safety & Warnings

- DO NOT install with power applied to the device.
- DO NOT expose the device to moisture.

With NFC Programming devices

Note

1) Do wiring according to the wiring diagram .

2) Recommend setting parameters without power-on devices .

2) Please make sure your mobile phone has NFC function and enable it .

Working with “SR NFC Tool” APP

Step 1: Download the APP (searching “SR NFC Tool” from App Store and Google Playstore) . Then open the APP .

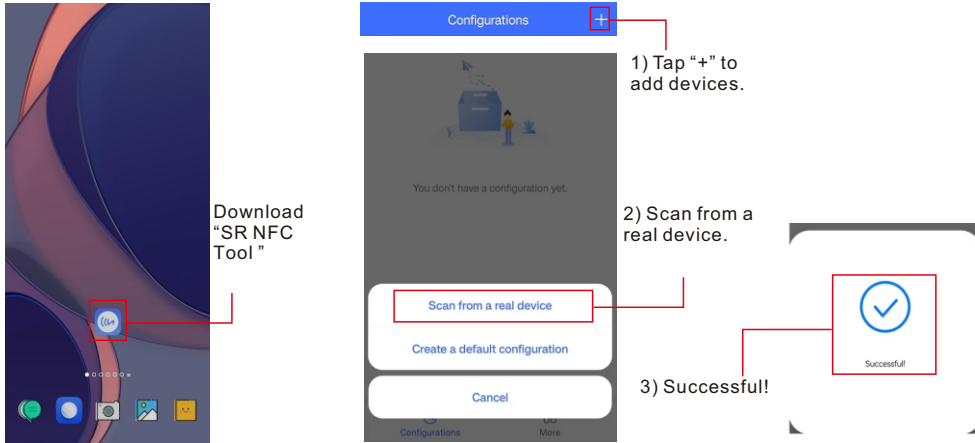

- Note:**
1. Please Make sure that you have enabled NFC function with your mobile phone/ tablet .
 2. Please Make sure that the “NFC position” is matched.
 3. Please do not power on the device before setting.
 4. If you can't download “SR NFC Tool”. Please contact with us.

Step 2: Add device, and name it as you wish.

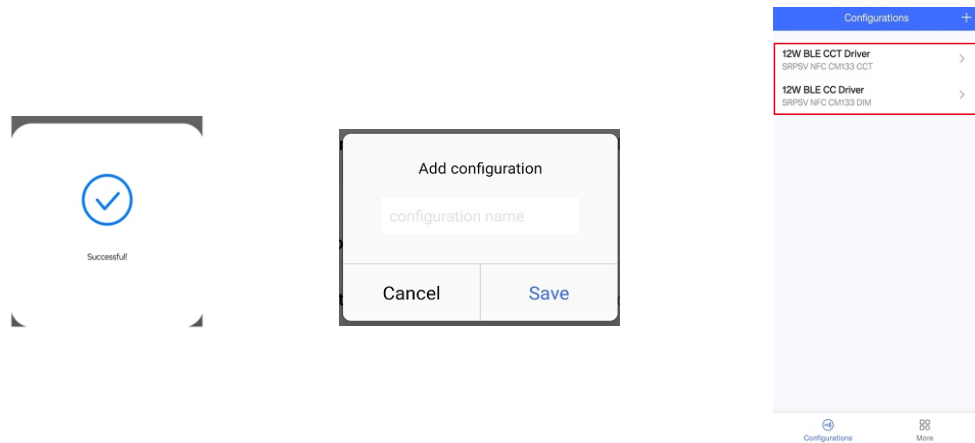

Step 3: Unlock device, enter parameters configuring page.

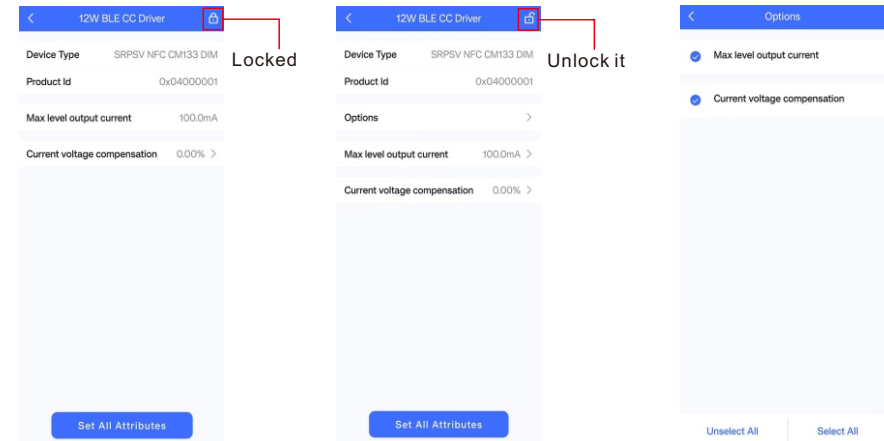

- Note:**
1. You have to unlock the device then do some settings
 2. Only when the corresponding function is selected, the function interface will be displayed.

Step 4: Few parameter interface, you can choose the setting based on your requirements.

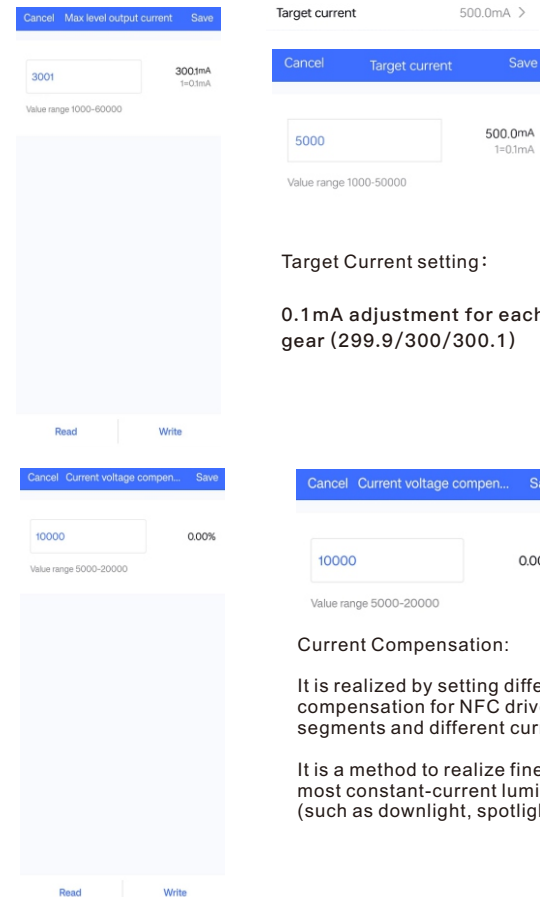

Target Current setting :

0.1mA adjustment for each current gear (299.9/300/300.1)

Current Compensation:

It is realized by setting different levels of current compensation for NFC drivers in different power segments and different currents of the driver.

It is a method to realize fine lighting control for most constant-current luminaries in the market (such as downlight, spotlight, panel light, etc.).

Step 5: After setting, please save the selected configuration via NFC and power on the device.

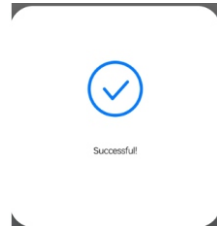
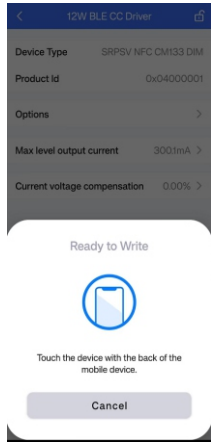

Tips

1. NFC function doesn't require any power driver.
2. Many functions can be configured by NFC. Kindly check your desired functions.
3. You can create a default profile with the "+" button.

Wiring Diagram

Application 1 (Without PUSH)

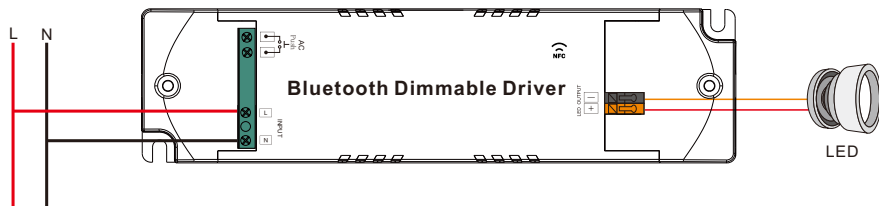

Application 2 (With PUSH)

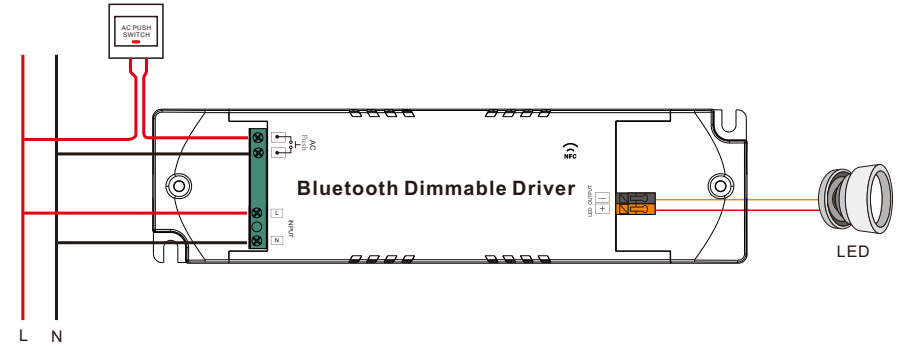

Product Dimension

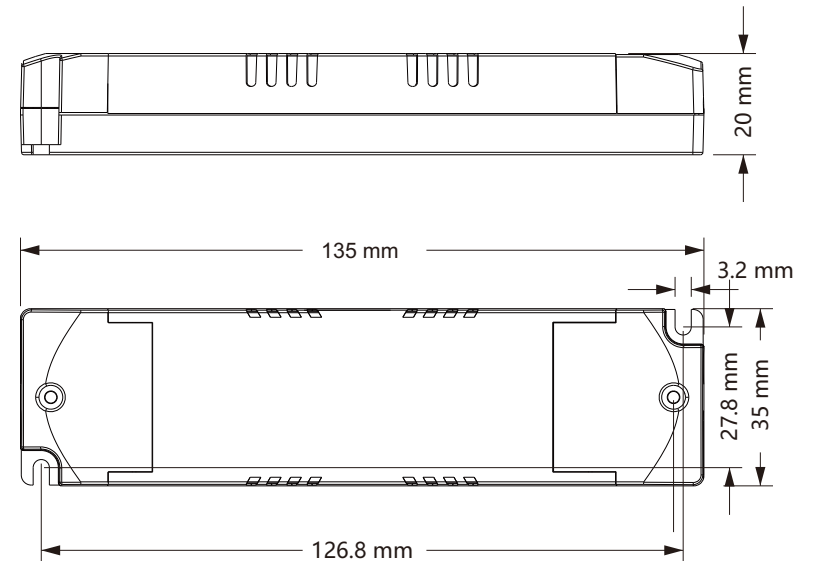

Operating window

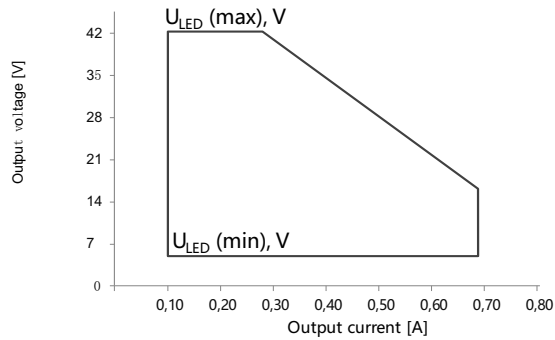

Dimming Curve

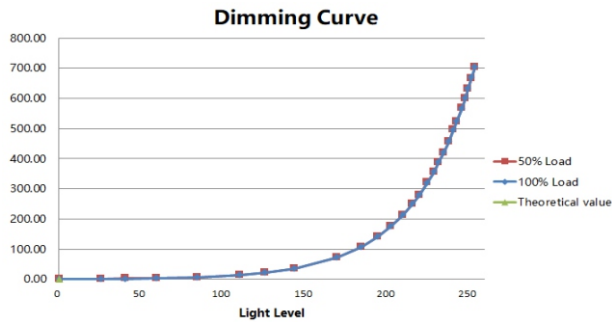

Note: Test data under 700mA gear

Driver Performance

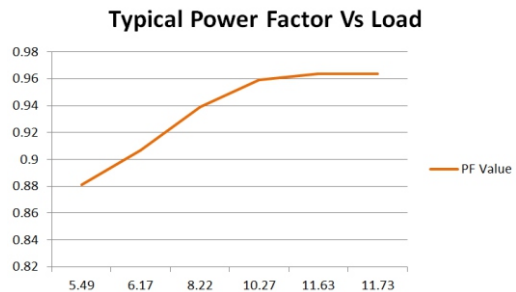

Note: Test data under 700mA gear

Driver Performance

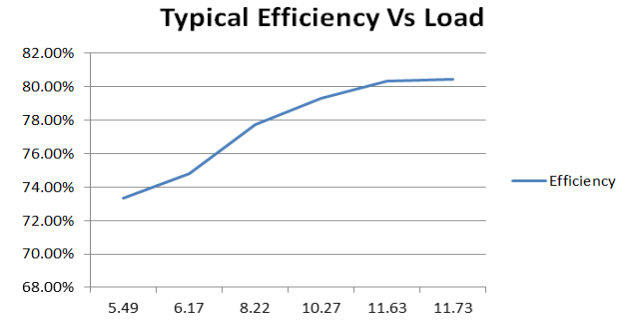

Note: Test data under 700mA gear

MCB Load Quantity

Module Number	I _{peak}	T _{width}	Max. quantity of LED Driver per MCB														
			B10	B13	B16	B20	B25	C10	C13	C16	C20	C25	D10	D13	D16	D20	D25
SRP-SV9105N-12CC100-700	3.96A	90μs	37	49	60	75	94	63	81	100	125	156	80	104	128	160	200
SRP-SV9105N-12CCT100-700	3.96A	90μs	37	49	60	75	94	63	81	100	125	156	80	104	128	160	200

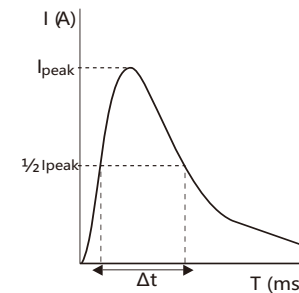

Note:

- 1.Those MCB parameters are based on ABB S200 series circuit breakers.
- 2.For different brands and models of miniature circuit breakers, the quantity of drivers will have difference.
- 3.Please do not exceed the above-mentioned quantity during on-site installation, and the specific load quantity shall be subject to on-site installation.
- 4.When the installation environment temperature of MCBs exceeds 30°C or when multiple MCBs are installed side by side, the number of mounted drives will be reduced, which requires recalculation.
- 5.Type C MCB's are strongly recommended to use with LED lighting

Update log

Date	Version	Update content	Update by
2024-1-8	V1.0	Initial Version	Romeo

Note: Subject to change without notice. Please contact us if you have any questions.