

# RGB CCT DIM 3 in 1 Zigbee Remote Controller

09.ZG2TU.04782



**Important:** Read All Instructions Prior to Installation

## Function introduction

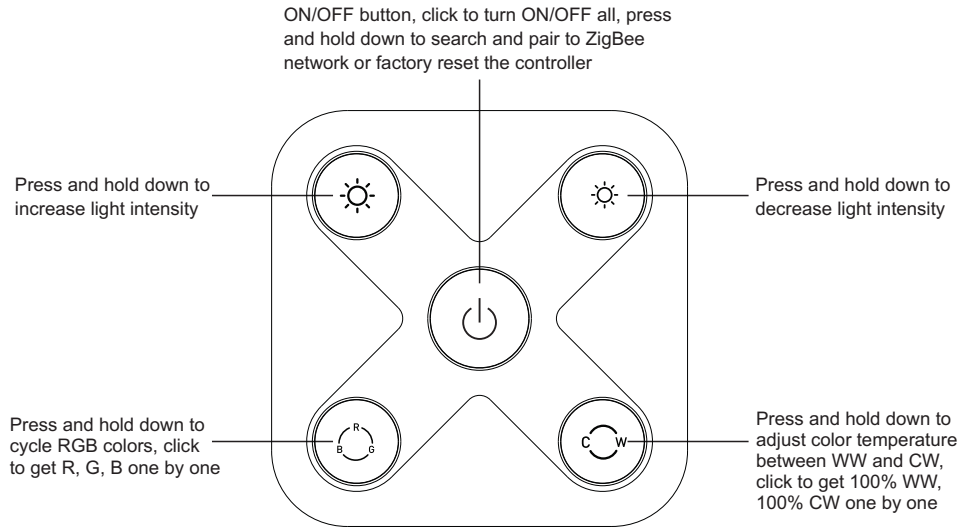

Front side

**Note:** This remote supports 1 group for binding max. 30 lighting devices.

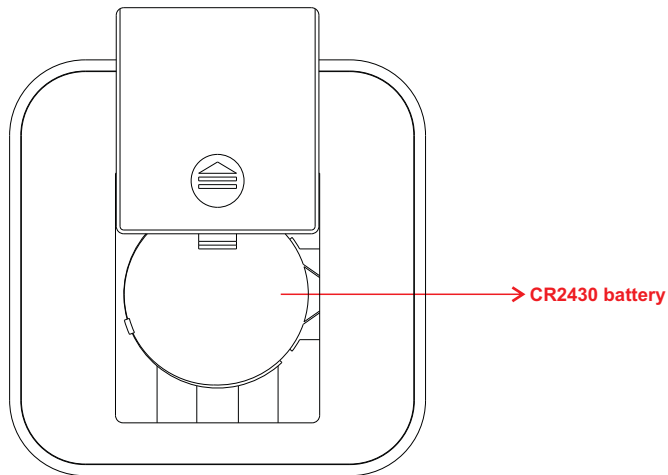

Back side

## Product Data

Operation Voltage	3VDC
Power Supply	3V(CR2430 battery)
Transmission Frequency	2.4GHz
Transmission Range (free field)	30m
Protection Type	IP20
Dimming Range	0.1%-100%

- RGB+CCT+DIM ZigBee remote controller based on ZigBee 3.0
- Supports 1 group for binding max. 30 lighting devices
- Supports TouchLink to pair to a lighting device directly
- 2.4 GHz global operation
- Long battery life mesh technology
- Transmission range up to 30m
- Compatible with ZigBee Gateway products
- Enables to bind and control universal DIM, CCT, RGB, RGBW and RGB+CCT zigbee lighting devices
- With magnet on the back, easy to be absorbed on metal surface

## ZigBee Clusters Supported by This Remote Are As Follows:

### Input clusters:

- Basic
- Power Configuration
- Identify
- Diagnostics

### Output clusters:

- Identify
- On/off
- Level control
- Ota
- Color control

## Safety & Warnings

- This device contains a button lithium battery that shall be stored and disposed properly.
- DO NOT expose the device to moisture.

## Operation

1. This ZigBee RGB+CCT remote is a wireless transmitter that communicates with a variety of ZigBee compatible systems. This transmitter sends wireless radio signals that are used to remotely control a compatible system.

2. This ZigBee remote supports 1 group for binding max. 30 lighting devices and enables to control both RGB and CCT ZigBee lighting devices.

## 3. Zigbee Network Pairing through Coordinator or Hub (Added to a Zigbee Network)

**Step 1:** Remove the remote from previous zigbee network if it has already been added to it, otherwise pairing will fail. Please refer to the part "Factory Reset Manually".

**Step 3:** Press and hold down until LED indicator turns on.

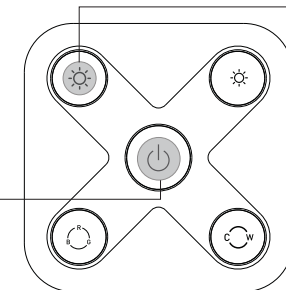

**Step 2:** From your zigbee controller or hub interface, choose to add device or accessory and enter Pairing mode as instructed by the controller.

**Step 4:** Immediately short press to search nearby network, indicator flashes every 1 second, 20 seconds timeout if there is no network. Indicator will then blink 5 times quickly for successful pairing.

**Note:** 1) After pairing successfully, the remote information will appear on the controller or hub interface.

2) No remote information will appear on the hub interface if pairing to Philips Hue Bridge.

#### 4. TouchLink to a Zigbee Lighting Device

**Step 1:** Set the zigbee lighting device to start TouchLink commissioning, please refer to its manual to learn how.

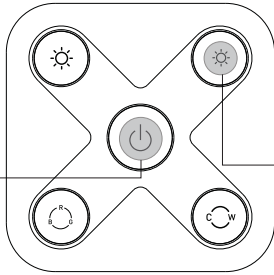

**Step 2:** Bring the remote within 10cm of the lighting device.

**Step 3:** Press and hold down until LED indicator turns on.

**Step 4:** Immediately short press to start TouchLink commissioning of the remote. LED indicator flashes fast for 3S, then flash 6 times slowly to indicate successful pairing to the device and the light connected to the device will blink twice.

**Note:** 1) Directly TouchLink (both not added to a ZigBee network), each remote can link with 30 devices.

2) TouchLink after both added to a ZigBee network, each remote can link with max. 30 devices.

3) For Hue Bridge & Amazon Echo Plus, add remote and device to network first then TouchLink.

4) After TouchLink, the remote can control the linked lighting devices.

#### 5. Removed from a Zigbee Network through Coordinator or Hub Interface

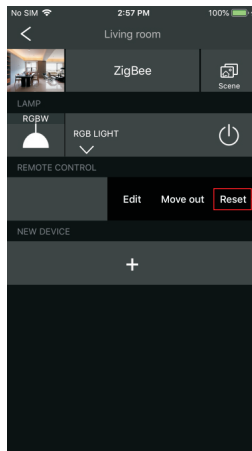

From your ZigBee controller or hub interface, choose to delete or reset the remote as instructed, indicator flashes 3 times quickly to indicate successful removing.

#### 6. Factory Reset Manually

**Step 1:** Press and hold down until LED indicator turns on.

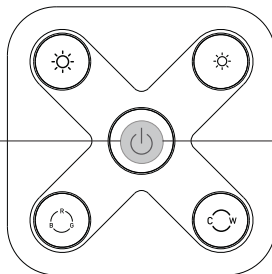

**Note:** All configuration parameters will be reset after the remote is reset or removed from the network.

**Step 2:** Immediately short press 5 times continuously, indicator flashes 3 times quickly to indicate successful reset.

#### 7. Remove a Touchlink Paired ZigBee Lighting Device

**Step 1:** Set the Touchlink paired zigbee device to start TouchLink commissioning, please refer to its manual to learn how.

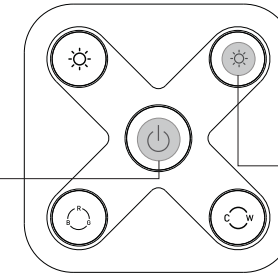

**Step 2:** Bring the remote within 10cm of the lighting device.

**Step 3:** Press and hold down until LED indicator turns on.

**Step 4:** Immediately short press twice to start TouchLink removing of the remote. LED indicator flashes fast for 3S, then flash 6 times slowly to indicate successful removing.

#### 8. Factory Reset a Lighting Device (Touch Reset)

**Note:** the device shall be added to a network, the remote added to the same one or not added to any network.

**Step 1:** Set the zigbee device to start TouchLink commissioning, refer to its manual.

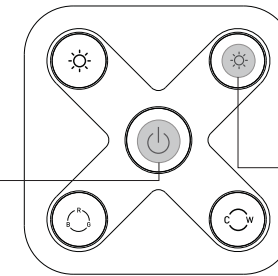

**Step 2:** Bring the remote within 10cm of the lighting device.

**Step 3:** Press and hold down until LED indicator turns on.

**Step 4:** Immediately short press 5 times to start Touch Reset of the remote. LED indicator flashes fast for 3S, then flash 3 times slowly to indicate successful reset.

#### 9. Find and Bind a Zigbee Lighting Device

**Note:** Make sure the device and remote already added to the same zigbee network.

**Step 1:** Start find and bind mode on the Zigbee lighting device (initiator node) and enable it to find and bind target, refer to its manual.

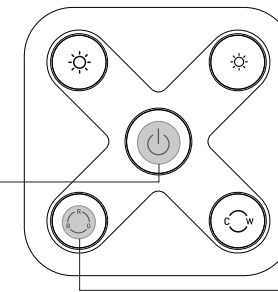

**Step 2:** Press and hold down until LED indicator turns on.

**Step 3:** Short press to enable the remote (target node) to find and bind initiator. LED indicator flashes 4 times for successful binding or twice if binding fails.

**Note:** Each remote can bind max. 30 lighting devices.

## 10. Find and Unbind a Zigbee Lighting Device

**Step 1:** Start find and bind mode on the Zigbee lighting device (initiator node) and enable it to find and bind target, refer to its manual.

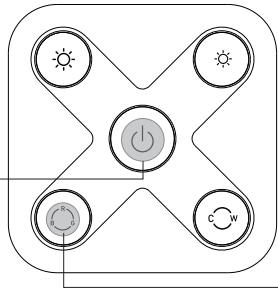

ZigBee Lighting Device

**Step 2:** Press and hold down until LED indicator turns on.

**Step 3:** Short press twice to enable the remote (target node) to find and unbind initiator. LED indicator flashes 4 times for successful unbinding or twice if unbinding fails.

## 11. Clear All Find and Bind Mode Paired Lighting Devices

**Step 1:** Press and hold down until LED indicator turns on.

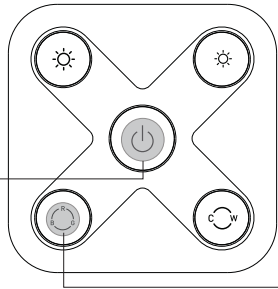

**Step 2:** Short press 5 times continuously to clear all bound lighting devices. LED indicator flashes 4 times for successful unbinding.

## 12. Setup a Network & Add Devices to the Network (No Coordinator or Hub Required)

**Step 1:** Factory reset the remote and the lighting device, refer to their manuals.

**Step 3:** Short press button to enable the network to discover and add devices, LED indicator will flash twice. 180 seconds timeout, repeat the operation.

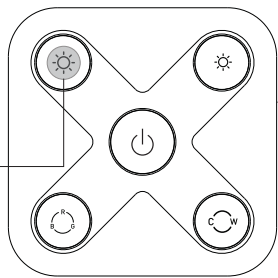

**Step 2:** TouchLink the remote and device to setup a network, refer to their manuals.

< 10cm

ZigBee Lighting Device

**Step 4:** Set another remote into network pairing mode and pair it to the network, refer to its manual.

**Step 5:** Add more remotes to the network as you would like.

**Step 6:** Factory reset the lighting devices that you would like to add to the network, refer to their manuals.

**Step 7:** Touchlink to pair the added remotes and lighting devices you would like to add, the devices will be added to the network through Touchlink, refer to their manuals.

## 13. OTA



The remote supports firmware updating through OTA, and will acquire new firmware from zigbee controller or hub every 10 minutes automatically.

## 14. How to Check Whether the Remote Belongs to a Network or not

Short press any button, indicator blinking means the remote has already been added to a network. No blinking of indicator means the remote does not belong to any network.

## 15. Battery Power Monitor Function

The remote will report battery power value to the coordinator under following situations:

- When powered on.
- When short pressing both brightness down button  and  button simultaneously.
- When operating the switch to send data packets (over 4 hours since last operation).
- When added to the network by a coordinator.