

DALI BLE Ceiling Mounted PIR Sensor Controller



Product Datasheet

Please read all instructions before installation



Product info

Reset Key: Long press it to help withdraw the device from internet/APP LED flashes quickly indicates success.

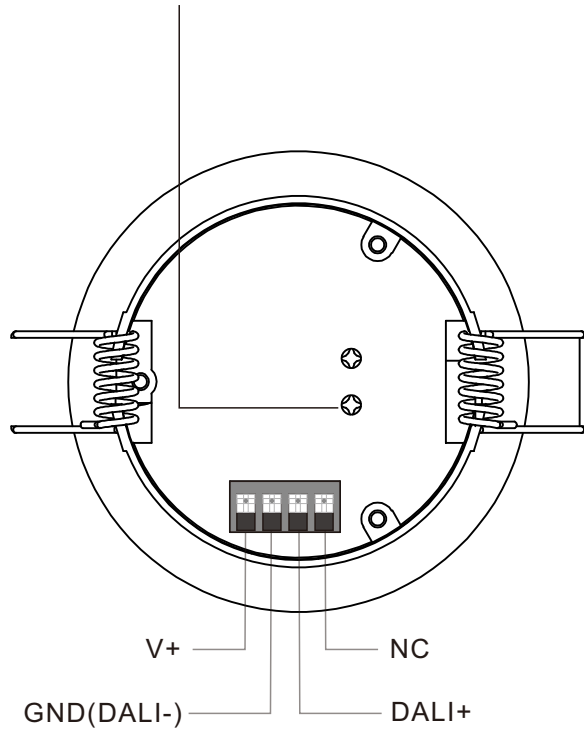
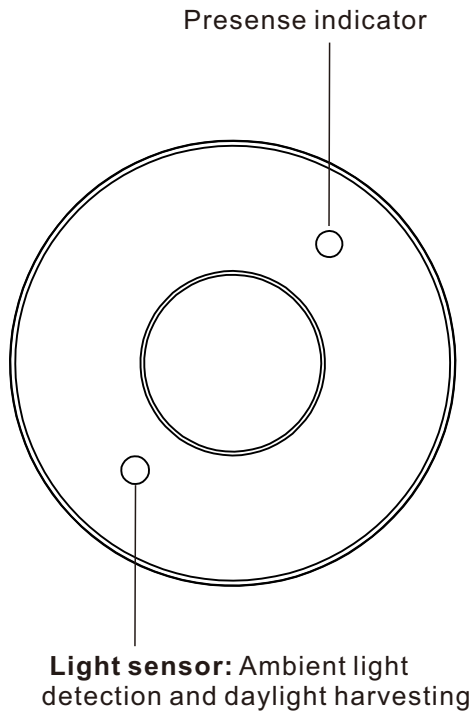

NC: No Connection

Parameters

Input		Output, DALI BUS	Control		Environment		Others
Power	Signal	Current	Dimming Curve	Dimming Method	Operating temperature	Relative humidity	Size
12-36VDC	Bluetooth	Max. 20mA	Logarithmic	PWM	-20°C-+50°C	8% to 80%	See dimensions

Features

- DALI BLE ceiling mounted sensor controller, Bluetooth® mesh network
- PIR sensing with daylight harvesting function
- Built-in 50mA DALI signal output
- Mesh network, which has a much longer control distance, transmits received signals to neighboring devices
- All devices on DALI line are broadcast controlled by mobile application
- Supporting our kinetic energy switches and EnOcean switches EWSSB and EWSDB
- In typical indoor environment, the range for wireless communication is 20m to 25m . Actual range is dependent on field installation.
- On-board antenna
- Available with Magnetic reset (Touch the top part of sensor for 5 seconds)
- Waterproof grade: IP20
- 5 years warranty

Dimension

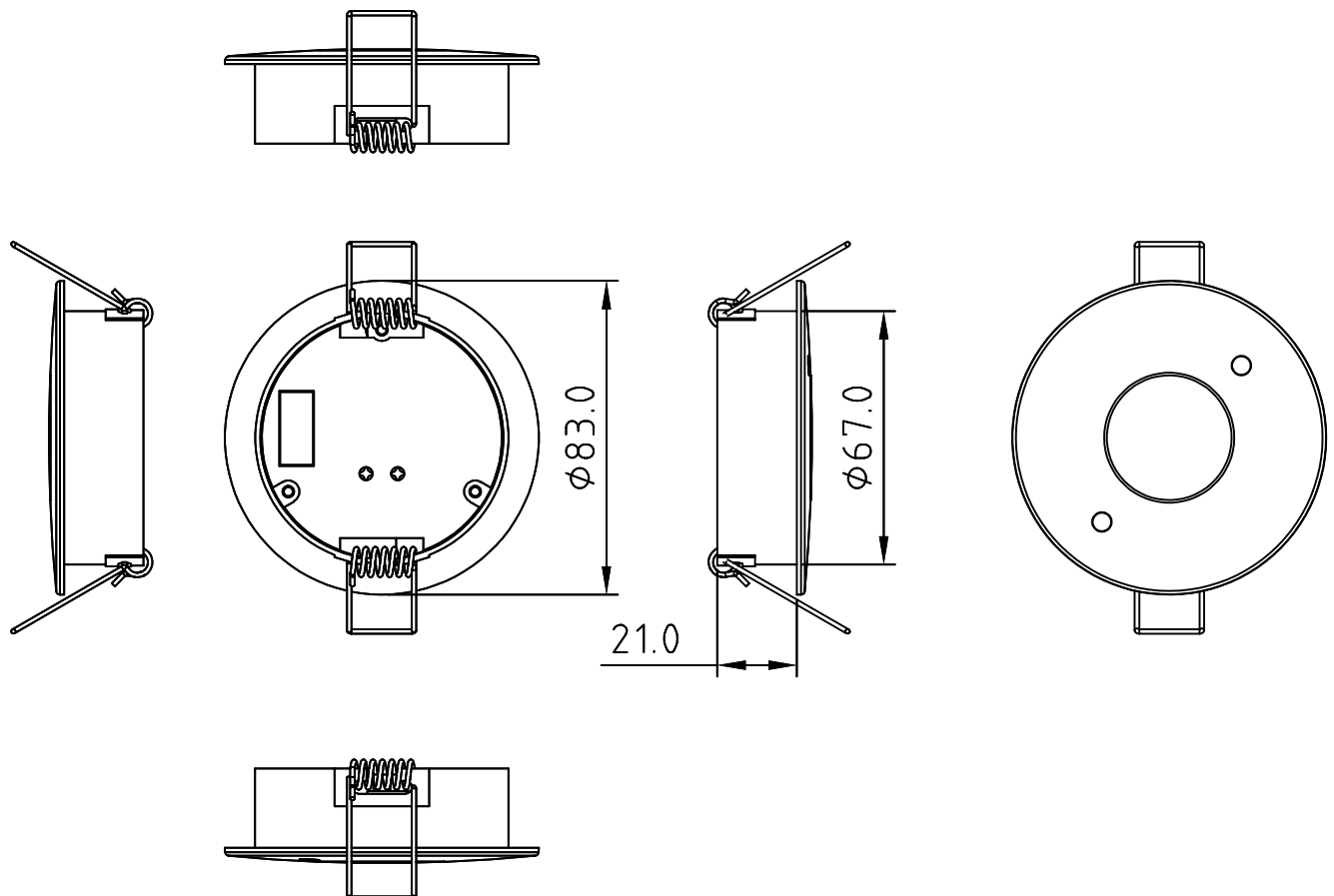

Application

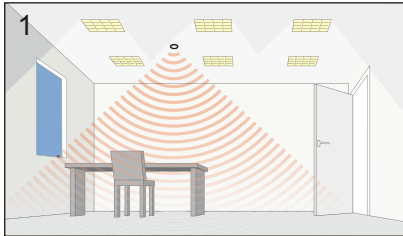

1. Power up the sensor. The load should come on immediately.

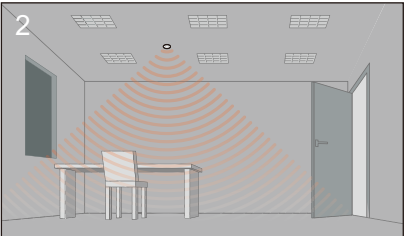

2. Vacate the room or remain very still and wait for the load to switch off.

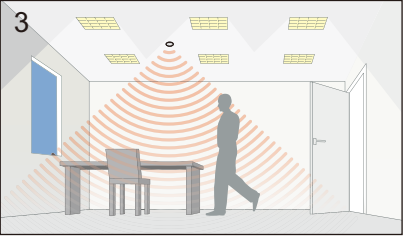

3. Enter the room or make some movement and check that the load switches on.

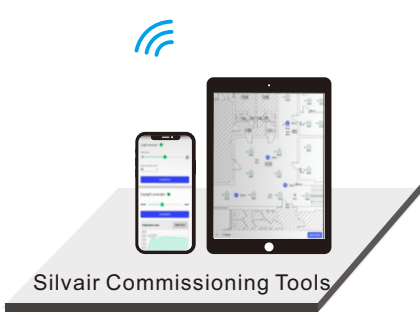

Silvair Commissioning Tools

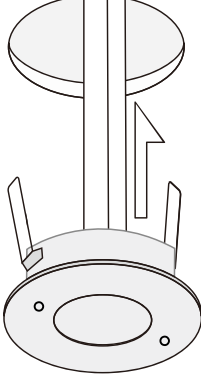

Bend the springs up and push detector through hole in ceiling. When fully inserted the springs snap back to hold the device in place. To avoid injury, take care when bending springs.

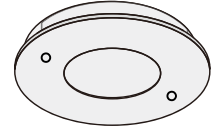

Installation complete.

Specifications

ENERGY SAVINGS

- Low/High-end trimming
- Daylight harvesting
- Occupancy/Vacancy detection
- Auto and advanced demand response programs
- Time-of-Day dimming schedule
- Energy monitoring

SENSING

- Testing height: 2.5m
- Detection area diameter: 5m @ 2.5m height

COMFORT & CONVENIENCE

- Advanced occupancy detections
- Light-level stability
- Configurable dim-and-linger occupancy
- Personalized setting profile
- Work with kinetic switch keypad and dimmer wallstation
- Multi-scenes control

ENVIRONMENT AND APPROBATION

- Operating temperature: -20°C to 55°C
- Agency approbations: CE/RoHS/UL Comming soon...
- Warranty: 5 years

Detection Pattern

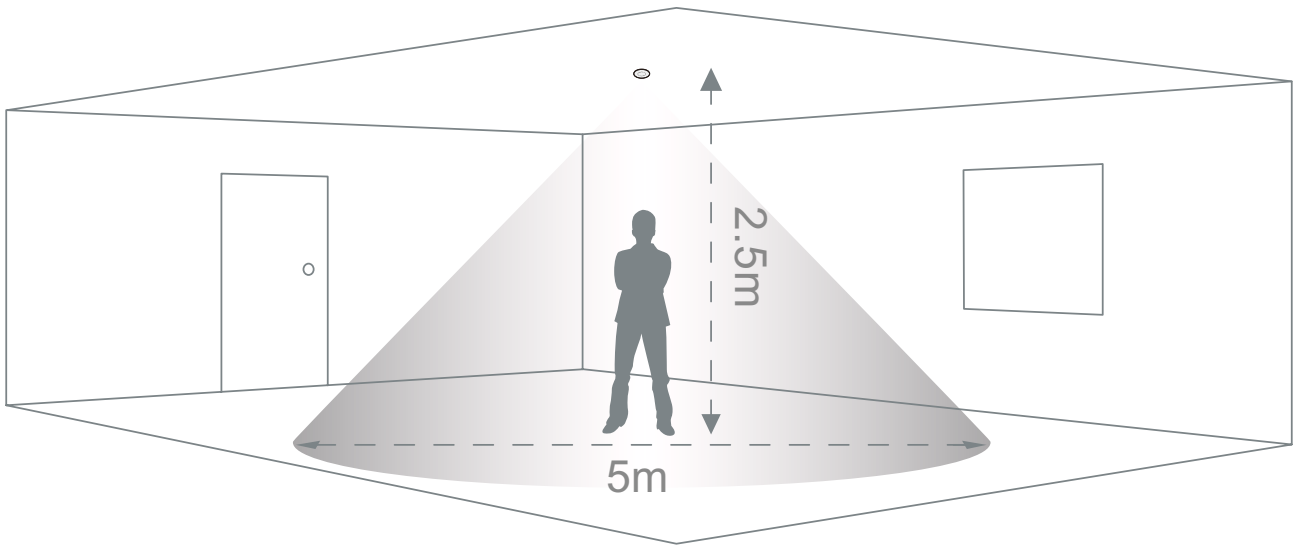

Coverage Side View

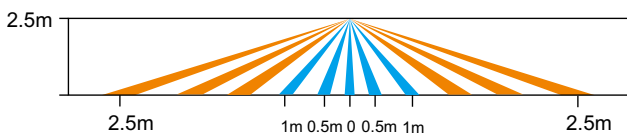

The detection area for movement sensor can be roughly divided into two parts:

- Slow movement (person moving <math>< 1.0'/s</math> or $0.3m/s$)
- Quick movement (person moving > $1.3'/s$ or $0.4m/s$)

Coverage Top View

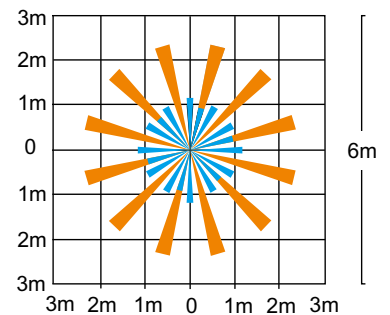

Warning

- DO NOT install with power applied to device
- DO NOT expose the device to moisture

Operation

- Do wiring according to connection diagram
- Kindly refer to **Silvair commissioning User Manual** for further pairing
- Press and hold down the “Reset” button on the controller over 5 seconds until the indicator flashes , which means it has been reset .
- Available with Magnetic reset (Touch the top part of sensor for 5 seconds)

Wiring

