

CONTENTS----- 1

1 PRODUCT DESCRIPTION & PARAMETERS ----- 2

1.1 PRODUCT DESCRIPTION ----- 2

1.2 ELECTRIC PARAMETERS ----- 2

1.3 WIRING DIAGRAM ----- 2

2 OPERATIONS ----- 3

2.1 KEY FUNCTION DEFINITION & DESCRIPTION ----- 3

2.1.1 Layout of Panel Keys (US Size) ----- 3

2.1.2 Key Function Definition (US Size) ----- 3

2.2 OPERATION INSTRUCTION ----- 4

2.2.1 LOCK & UNLOCK THE PANEL ----- 4

2.2.2 LIGHTING CONTROL ----- 4

3 FUNCTION DESCRIPTION ----- 4

3.1 GROUP STATUS INFORMATION PAGE ----- 4

3.1.1 Menu Items' Definition ----- 4

3.1.2 Page Operation ----- 5

3.2 GROUP CONFIGURATION FUNCTION ----- 5

3.2.1 Group Mode Setting ----- 5

3.2.2 Group Address Range Setting ----- 6

3.2.3 Time Schedule Setting ----- 7

3.2.4 Cycle Schedule Setting ----- 9

3.2.5 Scene Setting ----- 9

3.3 SYSTEM PARAMETER SETTING ----- 9

3.3.1 Entering into & Quitting from Setting Page ----- 10

3.3.2 Group Total Setting ----- 10

3.3.3 CCT Range Setting ----- 10

3.3.4 Cycle Time Scale Setting ----- 11

3.3.5 Beep Attribute Setting ----- 12

3.3.6 Vibrator Setting ----- 12

3.3.7 Lock Panel Setting ----- 13

3.3.8 OFF Display Setting ----- 13

3.3.9 System Time Setting ----- 14

3.3.10 Backlit Setting ----- 14

3.3.11 Factory Reset Setting ----- 14

4 INSTALLATION ----- 14

5 Master & PC Connection ----- 15



Important: Read All Instructions Prior to Installation

Safety & Warnings

- DO NOT install with power applied to device.
- DO NOT expose the device to moisture.

1. PRODUCT DESCRIPTION & PARAMETERS

1.1 PRODUCT DESCRIPTION

- The DMX512 control panel is a master controller designed to control the DMX decoders.
- It can control 512 DMX channels.
- It enables to configure max. 16 groups or zones with max. 8 scenes, 24 time schedules and 8 cycle schedules configured to each group.
- The panel supports 5 different types of DMX load: Dim, CCT, RGB, RGBW, RGB+CCT.
- 5 years warranty

1.2 ELECTRIC PARAMETERS

Output Signal	DMX512 signal
Power Supply	100-240VAC, 50/60Hz
Power consumption	< 15 mA
Operating temperature	0-40°C
Relative humidity	8% to 80%
Dimensions	75x120x41mm

1.3 WIRING DIAGRAM

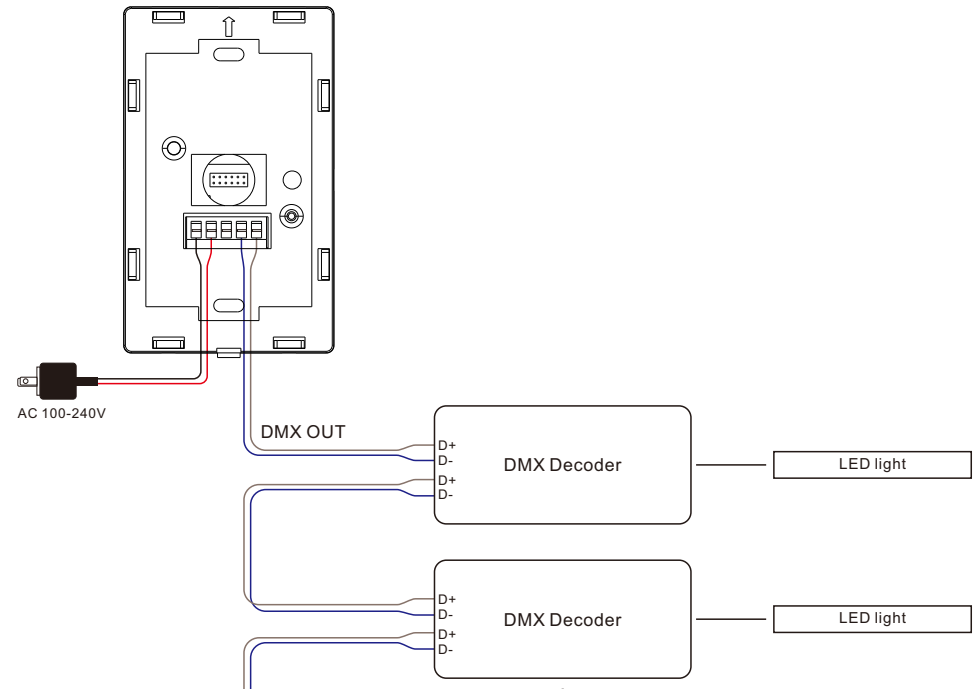

2. OPERATIONS

2.1 KEY FUNCTION DEFINITION & DESCRIPTION

2.1.1 Layout of Panel Keys (US Size)

2.1.2 Key Function Definition (US Size)

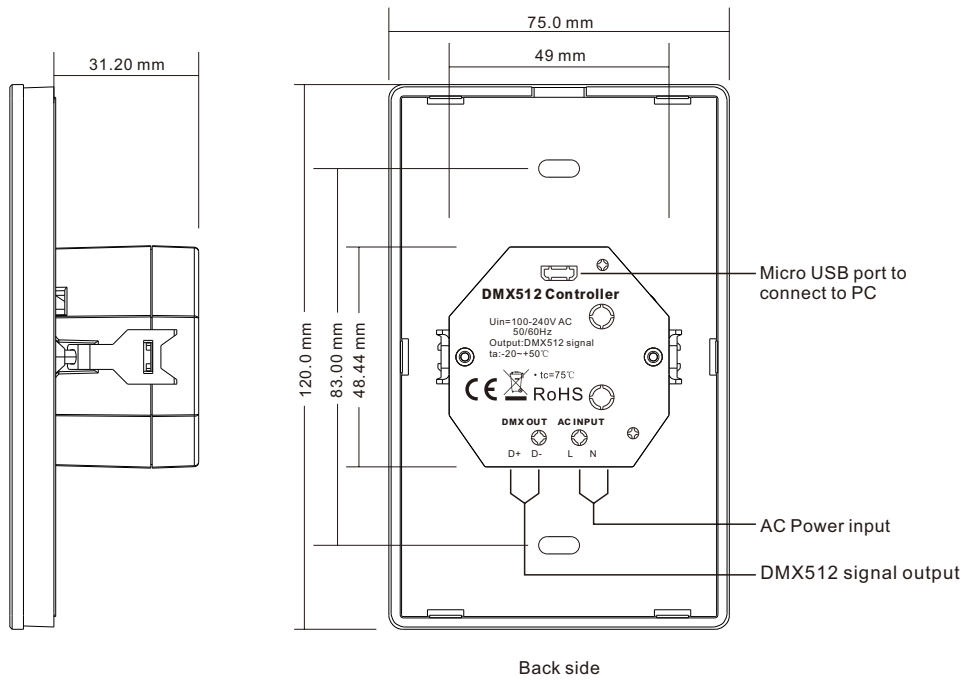
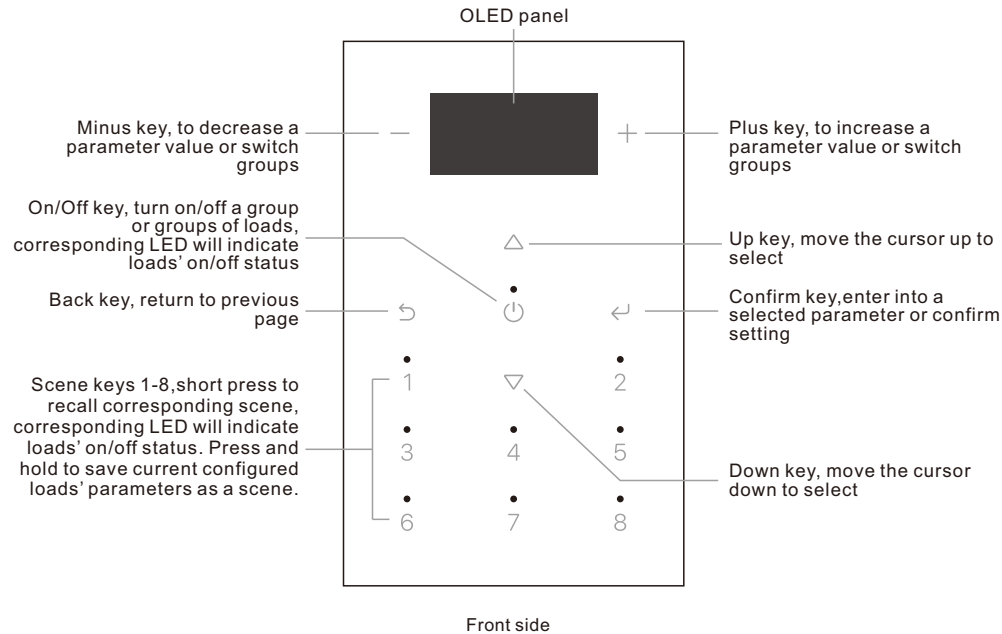

2.2 OPERATION INSTRUCTION

2.2.1 LOCK & UNLOCK THE PANEL



Figure 2

Unlock The Panel:

As shown in following Figure 2, there is a lock icon at the top right corner of the display, which means the panel is locked. Press and hold both Up key and Down key for approximate 1 second, the panel will be unlocked, the lock icon will disappear, the display will show Group information page.

Lock The Panel:

Lock the panel automatically, after the panel is powered on or panel keys to be locked, the panel is under unlocked status, if automatic lock function is enabled, when the lock time elapses, and there is no operation of the keys, the panel will be locked.

Lock the panel manually, under unlocked status, press and hold both Up key and Down key for approximate 1 second, the panel will be locked.

2.2.2 LIGHTING CONTROL

On/Off Key:

Under unlocked status, short press On/Off key, if any lighting devices in current Group is on, all lighting devices in current Group will be turned off, if lighting devices in current Group is off, all lighting devices in current Group will be turned on.

Scene Keys:

Short press a scene key, the lighting devices in current Group will go to the configured scene parameters. There are total 1-8 scene keys, which means 8 scenes for each Group. Corresponding LED will indicate the loads' on/off status.

3. FUNCTION DESCRIPTION

3.1 GROUP STATUS INFORMATION PAGE

3.1.1 Menu Items' Definition



Figure 3

Current Group status information page is as shown in following Figure 3, the menu items definitions are as follows:

G01: Current group is Group 1

Zone01: Current group name

RGBCCT: Current group mode is RGBCCT mode

Brightness: Current group brightness percentage

R: Current group red color value

G: Current group green color value

B: Current group blue color value

CCT: Current group color temperature value

3.1.2 Page Operation

Parameter Selection:

Short press Up key Δ or Down key ∇ to select a parameter. When the parameter font color is black and background color is white, the parameter is selected.

Parameter Value Modification:

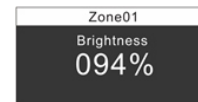

Figure 4

If a selected parameter item is an attribute of lighting devices, short press Plus key $+$ or Minus key $-$ to increase or decrease parameter value of the selected parameter. Press and hold Plus key $+$ or Minus key $-$ to pop up a window of selected parameter and increase or decrease parameter value continuously. As shown in following Figure 4. Release the key, the pop-up window will be closed automatically after 5 seconds, also the pop-up window can be closed by short pressing the Back key \curvearrowright .

Switch to Another Group or Zone:

If the selected parameter item is Group information, short press Plus key $+$ or Minus key $-$ to switch to another different group or zone.

Parameter Preview & Save:

Short press Confirm key \leftarrow , lighting devices in current group will go to the modified group parameters' value. Press and hold Scene keys (1-8) to save the current parameters' value as the group's corresponding scene. Once saved successfully, the blank area of the display will show "OK".

Page Switch:

Short press Back key \rightarrow to switch to Group configuration page, short press Back key \rightarrow again to switch to Group status information page. The Group configuration page and Group status information page can be switched alternately by operate the Back key \rightarrow .

3.2 GROUP CONFIGURATION FUNCTION

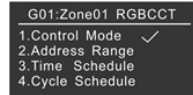

Figure 5



Figure 6

Short press Back key \rightarrow to switch to Group configuration function page. Page 1 of Group configuration page is as shown in following Figure 5, short press Up key \triangle or Down key ∇ to switch setting of different functions, Page 2 of Group configuration page is as shown in following Figure 6. There are total 5 different functions can be set. Tick a function to select it and then short press Confirm key \leftarrow to enter into the function setting page of selected item.

On Group configuration function page (Figure 5/Figure 6), operate Plus key $+$ or Minus key $-$ to switch current group to another.

3.2.1 Group Mode Setting

Enter into Group Mode Setting Page



Figure 7

Enter into Group configuration function page as shown in Figure 5 and Figure 6, short press Up key \triangle or Down key ∇ to select "1. Control Mode", short press Confirm key \leftarrow to enter into Group Mode setting page as shown in following Figure 7.

Mode Modification

Short press Up key \triangle /Down key ∇ or Plus key $+$ /Minus key $-$ to modify current mode, the mode with black font color and white background color is current selected mode. There are 5 different modes available. (Dim, CCT, RGB, RGBW, RGBCCT)

Mode Saving

Short press Confirm key \leftarrow to confirm and save the modified mode. The blank area of the display will show "Save OK" which means the mode is saved. Short press Back key \rightarrow to return to Group configuration page.

3.2.2 Group Address Range Setting

Enter into Group Address Range Setting Page

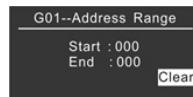

Figure 8

Enter into Group configuration function page as shown in Figure 5 and Figure 6, short press Up key \triangle /Down key ∇ to select "2.Address Range", short press Confirm key \leftarrow to enter into Group address range setting page as shown in following Figure 8.

Group Address Parameter Items Selection

There are 3 parameter items which can be modified for Group Address: start address, end address, clear. Short press Up key \triangle /Down key ∇ to switch and select a parameter item. The parameter item with black font color and white background color is selected.

Group Address Modification

Short press Plus key $+$ /Minus key $-$ to modify the selected parameter item, address range available for modification is 1-512. If "Clear" parameter item is selected, short press Confirm key \leftarrow to execute clear address range function, once cleared, the start address and end address are both 0.

Notes:

- Address range of any group shall be within 1-512.
- Start address of any group shall not exceed end address.
- Address range of current group shall be a multiple of the output channel quantity of current selected

control mode.

- Address range of different groups shall not cross and repeat.

Group Address Saving

Short press Confirm key \leftarrow to save modified address parameters of current group. Short press Back key \rightarrow to return to Group configuration page.

3.2.3 Time Schedule Setting

Time Schedule Introduction

Time Schedule is a timing task, each group has 24 timing tasks, when "date" or "week" is selected and current timing task is enabled, when real time is the same as the scheduled task time, the lighting devices in the group will go to the parameters set under the timing task.

There are two types of time schedule:

- Non-repeated time schedule based on a detailed date
- Repeated time schedule based on week period

Enter into Time Schedule Setting Page

Enter into Group configuration function page as shown in Figure 5 and Figure 6, short press Up key \triangle /Down key ∇ to select "3. Time Schedule", short press Confirm key \leftarrow to enter into Group Time Schedule setting page as shown in following Figure 9 to Figure 16.

Time Schedule Parameter Items Selection

Short press Up key \triangle /Down key ∇ to switch and select the parameter items, the parameter item with underline is selected.

Time Schedule Parameter Items Introduction:

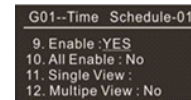

Figure 9

Time schedule type: non-repeated time schedule (date)

Assume current group with control mode RGBCCT as an example to introduce the parameter items as shown in Figure 9 to Figure 12. (Parameter items are different due to different control modes.)

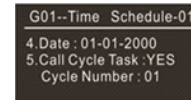

Figure 10

"1. Time Schedule" is serial number of a timing task, there are total 24 timing tasks, modification range is 1-24.

"2. Timer Type" is the type of the timing task, which has two types "week" and "date"

"3. Time" is the scheduled time of the task (Hour:Minute:Second)

"4. Date" is the detailed date (Date-Month-Year) of the timing task when type "date" Timer Type is selected



Figure 11

"5. Call Cycle Task" is the switch for time schedule to recall corresponding cycle task, "YES" means enabled, "NO" means disabled. "Cycle Number" is the serial number of the cycle task to be recalled, modification range is 1-8, current default is to recall Cycle number=1, others are for future extension.

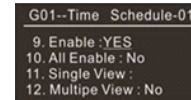

Figure 12

"6. Brightness" is the brightness percentage of the group, modification range is 0-100.

"7. Color" is the RGB values of the group, modification range is 0-255.

"8. CCT" is the CCT value of the group, modification range please refer to system parameter setting 3.3.3 CCT Range.

"9. Enable" is the function to enable or disable current timing task, "YES" means enable, "NO" means disable.

"10. All Enable" is to enable or disable all timing tasks of current group, "YES" means enable, "NO" means disable.

"11.Single View" is to preview current timing task.

"12.Multiple View" is to preview all timing tasks enable or disable status in current group, "YES" means enable, "NO" means disable.

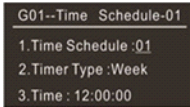

Figure 13

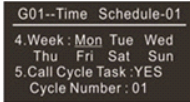

Figure 14

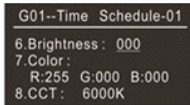

Figure 15

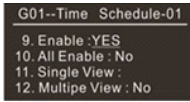

Figure 16

Time schedule type: repeated time schedule (week)

Assume current group with control mode RGB CCT as an example to introduce the parameter items as shown in Figure 13 to Figure 16. (Parameter items are different due to different control modes.)

"1. Time Schedule" is serial number of a time task, there are total 24 time tasks, modification range is 1-24.

"2. Timer Type" is the time type of the timing task, which has two types "week" and "date"

"3. Time" is the scheduled time of the task (Hour:Minute:Second)

"4. Week" is the week (Monday to Sunday) of the timing task when type "week" Timer Type is selected, when corresponding week shows black font color and white background, the week is activated as the cycle week of the timing task.

"5. Call Cycle Task" is the switch for time schedule to recall corresponding cycle task, "YES" means enabled, "NO" means disabled. "Cycle Number" is the serial number of the cycle task to be recalled, modification range is 1-8, current default is to recall Cycle number=1, others are for future extension.

"6. Brightness" is the brightness percentage of the group, modification range is 0-100.

"7. Color" is the RGB values of the group, modification range is 0-255.

"8. CCT" is the CCT value of the group, modification range please refer to system parameter setting 3.3.3 CCT Range.

"9. Enable" is the function to enable or disable current timing task, "YES" means enable, "NO" means disable.

"10. All Enable" is to enable or disable all timing tasks of current group, "YES" means enable, "NO" means disable.

"11. Single View" is to preview current timing task.

"12. Multiple View" is to preview all timing tasks enable or disable status in current group, "YES" means enable, "NO" means disable.

Time Schedule Parameter Value Modification

Short press Plus key + /Minus key - to modify current selected parameter item value. Press and hold Plus key + /Minus key - to increase/decrease value rapidly.

Once any parameter item is selected, press and hold On/Off key ⏻, meanwhile after approximate 1 second, short press Plus key + /Minus key - to switch the serial number of the time schedules.

Time Schedule Parameter Saving

Short press Confirm key ↵ to confirm and save current modified parameter. The blank area of the display will show "OK" to indicate saving successfully. Short press Back key ⏪ to return to group configuration page.

3.2.4 Cycle Schedule Setting

Cycle Schedule Introduction

Cycle Schedule is a periodical cycle action, each group has 1 periodical cycle action, which includes 8 steps,

(you can program max. 8 colors for the cycle action), when corresponding periodical cycle action is activated, the lighting devices in the group will turn on based on the time setting parameters "Stay Time" and "Fade Time" of the cycle action.



Figure 17

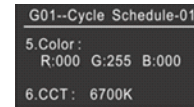

Figure 18

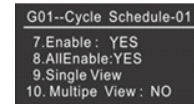

Figure 19

Enter into Cycle Schedule Setting Page

Enter into Group configuration function page as shown in Figure 5 and Figure 6, short press Up key △ /Down key ▽ to select "4. Cycle Schedule", short press Confirm key ↵ to enter into Cycle Schedule setting page as shown in following Figure 17 to Figure 19.

Cycle Schedule Parameter Items Selection

Short press Up key △ /Down key ▽ to switch and select a parameter item. The item with underline is selected.

Cycle Schedule Parameters Introduction:

Assume current group with control mode RGB CCT as an example to introduce the parameter items as shown in Figure 17 to Figure 19. (Parameter items are different due to different control modes.)

"1. Setp" is the serial number of 8 steps, there are total max. 8 colors can be programmed for the periodical action, selectable range is 1-8.

"2. Stay Time" is stay time of current selected programmed color.

"3. Fade Time" is the fade time from current programmed color to next color.

"4. Brightness" is the brightness percentage of current programmed color, modification range is 0-100.

"5. Color" is the RGB values of the current programmed color, modification range is 0-255.

"6. CCT" is the CCT value of current programmed color, modification range please refer to system parameter setting 3.3.3 CCT Range.

"7. Enable" is the function to enable or disable current programmed color, "YES" means enable, "NO" means disable.

"8. All Enable" is to enable or disable all programmed colors of the cycle periodical action, "YES" means enable, "NO" means disable.

"9. Single View" is to preview current programmed color.

"10. Multiple View" is to enable or disable to preview all programmed colors in the cycle periodical action, "YES" means enable, "NO" means disable.

Note: The actual duration of StayTime and FadeTime shall be associated with 3.3.4 Cycle Time Scale setting value.

Cycle Schedule Parameter Value Modification

Short press Plus key + /Minus key - to modify current selected parameter item value. Press and hold Plus key + /Minus key - to increase/decrease value rapidly.

Once any parameter item is selected, press and hold On/Off key ⏻, meanwhile after approximate 1 second, short press Plus key + /Minus key - to switch the serial number of the cycle schedules.

Cycle Schedule Parameter Saving

Short press Confirm key ↵ to confirm and save current modified parameter. The blank area of the display will show "OK" to indicate saving successfully. Short press Back key ⏪ to return to group configuration page.

Quick Start Function of the Cycle Schedule

Short press both Confirm key \leftarrow and any of the scene keys (1-8) simultaneously, the master controller will start the cycle action with corresponding cycle number. (Current version only includes Cycle Number=1)

3.2.5 Scene Setting

Scene Setting Introduction

Scene Setting is to set scene parameter value of each group, there are max. 16 groups, and each group has 8 scenes.



Figure 20

Enter into Scene Setting Page

Enter into Group configuration function page as shown in Figure 5 and Figure 6, short press Up key \triangle /Down key ∇ to select "5.Scene Setting", short press Confirm key \leftarrow to enter into Scene Setting page as shown in following Figure 20.

Scene Setting Parameter Items Selection

Short press Up key \triangle /Down key ∇ to switch and select a parameter item. The item with underline is selected.

Scene Setting Parameter Items Introduction:

Assume current group with control mode RGB CCT as an example to introduce the parameter items as shown in Figure 20. (Parameter items are different due to different control modes.)

"1. Brightness" is the brightness percentage of the group, modification range is 0-100.

"2. Color" is the RGB values of the group, modification range is 0-255.

"3. CCT" is the CCT value of the group, modification range please refer to system parameter setting 3.3.3 CCT Range.

Scene Setting Parameter Value Modification

Short press Plus key $+$ /Minus key $-$ to modify current selected parameter item value. Press and hold Plus key $+$ /Minus key $-$ to increase/decrease value rapidly.

Scene Setting Parameter Preview & Saving

Short press Confirm key \leftarrow , the lighting devices in the group will go to the modified scene parameters, corresponding LED will indicate the loads' on/off status.

Press and hold Scene number keys (1-8) to save the modified parameters as a corresponding scene of the group. The blank area of the display will show "OK" to indicate saving successfully.

Short press a scene number key (1-8), the lighting device will go to corresponding scene and show the scene parameter values on the display.

Short press Back key \rightarrow to return to group configuration page.

3.3 SYSTEM PARAMETER SETTING

3.3.1 Entering into & Quitting from System Parameter Setting Page

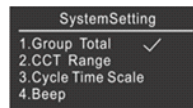

Figure 21

When the panel is unlocked, press and hold both Plus key $+$ and Minus key $-$ for approximate 1 second to enter into system parameter setting page as shown in following Figure 21 to Figure 23. There are 3 pages for the system parameter setting.

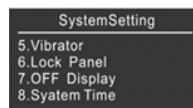

Figure 22

On the system parameter setting page, press and hold both Plus key $+$ and Minus key $-$ for approximate 1 second to quit from the page. Or press and hold Back key \rightarrow to quit.



Figure 23

3.3.2 Group Total Setting

Group Total Setting Introduction

Group Total is the total valid group quantity that the DMX512 master system has, modification range is 1-16.

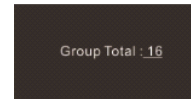

Figure 24

Enter into Group Total Setting Page

Enter into System parameter setting page as shown in Figure 21 to Figure 23, short press Up key \triangle /Down key ∇ to select "1.Group Total", short press Confirm key \leftarrow to enter into Group Total Setting page as shown in following Figure 24.

Group Total Parameter Value Modification

Short press Plus key $+$ /Minus key $-$ to modify total valid group quantity. Press and hold Plus key $+$ /Minus key $-$ to increase/decrease quantity rapidly.

Group Total Parameter Saving

Short press Confirm key \leftarrow to confirm and save current modified parameter. The blank area of the display will show "Save OK" to indicate saving successfully. Short press Back key \rightarrow to return to system parameter setting page.

3.3.3 CCT Range Setting

CCT Range Setting Introduction

CCT Range is the valid CCT value modification range. "WW" is the value of warm white, valid modification range is 1000-4000. "CW" is the value of cool white, valid modification range is 5000-10000.

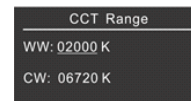

Figure 25

Enter into CCT Range Setting Page

Enter into system parameter setting page as shown in Figure 21 to Figure 23, short press Up key \triangle /Down key ∇ to select "2.CCT Range", short press Confirm key \leftarrow to enter into CCT range Setting page as shown in following Figure 25.

CCT Range Parameter Items Selection

Short press Up key \triangle /Down key ∇ to switch and select a parameter item.

CCT Range Parameter Value Modification

Short press Plus key $+$ /Minus key $-$ to modify the selected parameter item. Press and hold Plus key $+$ /Minus key $-$ to increase/decrease parameter value rapidly.

CCT Range Parameter Saving

Short press Confirm key \leftarrow to confirm and save current modified parameter. The blank area of the display will show "Save OK" to indicate saving successfully. Short press Back key \rightarrow to return to system parameter setting page.

3.3.4 Cycle Time Scale Setting

Cycle Time Scale Setting Introduction

CycleTimeScale is to set the time scale factor for all cycle schedules' Stay Time (StayTime) and Fade Time (FadeTime), which can adjust the speed of LED lighting color, color temperature fading.

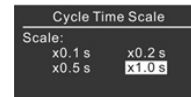

Figure 26

Enter into Cycle Time Scale Setting Page

Enter into System parameter setting page as shown in Figure 21 to Figure 23, short press Up key \triangle /Down key ∇ to select "3.Cycle Time Scale", short press Confirm key \leftarrow to enter into Cycle Time Scale Setting page as shown in following Figure 26.

CycleTimeScale Parameter Items Introduction:

The meaning of each parameter item are described as shown in Figure 26.

x0.1 s:

The stay time of stay cycle schedules=Stay Time Parameter Value*0.1S (Second)
The fade time of fade cycle schedules=Fade Time Parameter Value*0.1S (Second)

x0.2s:

The stay time of stay cycle schedules=Stay Time Parameter Value*0.2S (Second)
The fade time of fade cycle schedules=Fade Time Parameter Value*0.2S (Second)

x0.5s:

The stay time of stay cycle schedules=Stay Time Parameter Value*0.5S (Second)
 The fade time of fade cycle schedules=Fade Time Parameter Value*0.5S (Second)

x1.0s:

The stay time of stay cycle schedules=Stay Time Parameter Value*1.0S (Second)
 The fade time of fade cycle schedules=Fade Time Parameter Value*1.0S (Second)

Cycle Time Scale Parameter Modification

Short press Up key Δ /Down key ∇ or Plus key $+$ /Minus key $-$ to modify current parameter value, the value with black font color and white background color is current modified value.

Cycle Time Scale Parameter Saving

Short press Confirm key \leftarrow to confirm and save current modified parameter. The blank area of the display will show "Save OK" to indicate saving successfully. Short press Back key \rightarrow to return to system parameter setting page.

Note: regarding the set parameter value of the time scale factor CycleTimeScale, please refer to the following table. (Single Scene Stay Time Average Min Data(ms), is just a similar reference time value.)

Item	Cycle Schedule Group Enable Total	Fade Time=0 Group Total	Single Scene Stay Time Average Min Data(ms)	Suggest Cycle Time Scale Min Data
1	1	1	140ms	x0.1
2	2	1	200ms	x0.2
3*	3	1	300ms	x0.2
4*	4	1	400ms	x0.2
5	5~6	1	500ms	x0.5
6*	7~8	1	600ms	x0.5
7*	9	1	900ms	x0.5
8	10~16	1	1000ms	x1.0

Note: when the items are 3, 4, 6, 7, within the max value range of Cycle Schedule Group Enable Total, when Fade Time=0, Group Total>1, the value of Single Scene Stay Time Average Min Data(ms) will be a little lower than reference values in above table.

3.3.5 Beep Attribute Setting**Beep Attribute Setting Introduction**

Beep attribute setting is to set the parameter of the beeper. When the beeper is enabled, and the key is pressed, the beeper will beep once to indicate that a key is pressed.

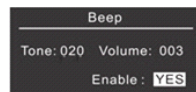

Figure 27

Enter into Beep Setting Page

Enter into System parameter setting page as shown in Figure 21 to Figure 23, short press Up key Δ /Down key ∇ to select "4.Beep", short press Confirm key \leftarrow to enter into Beep Setting page as shown in following Figure 27.

Beep Parameter Items Introduction:

- Tone is to modify the tone of beeper, modification range is 1-100.
- Volume is to modify the sound volume of the beeper, modification range is 1-100.
- Enable is to enable or disable the beeper, "YES" means beeper function enabled, "NO" means the function disabled.

Beep Setting Parameter Items Selection

Short press Up key Δ /Down key ∇ to select a parameter item, the parameter with black font color and white background color is current selected item.

Beep Setting Parameter Modification

Short press Plus key $+$ /Minus key $-$ to modify the selected parameter item. Press and hold Plus key $+$ /Minus key $-$ to increase/decrease parameter value rapidly.

Beep Setting Parameter Saving

Short press Confirm key \leftarrow to confirm and save current modified parameter. The blank area of the display will show "Save OK" to indicate saving successfully. Short press Back key \rightarrow to return to system parameter setting page.

3.3.6 Vibrator Setting**Vibrator Setting Introduction**

Vibrator setting is to set the vibrator parameters. When the vibrator is enabled, and a key is pressed, the vibrator will vibrate once to indicate a key is pressed.

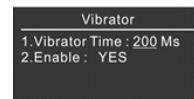

Figure 28

Enter into Vibrator Setting Page

Enter into System parameter setting page as shown in Figure 21 to Figure 23, short press Up key Δ /Down key ∇ to select "5.Vibrator", short press Confirm key \leftarrow to enter into Vibrator Setting page as shown in following Figure 28.

Vibrator Parameter Items Introduction:

- Vibrator Time is to modify the vibrating time of the vibrator, modification range is 0-500.
- Enable is to enable or disable the vibrator, "YES" means vibrator function enabled, "NO" means the function disabled.

Vibrator Parameter Items Selection

Short press Up key Δ /Down key ∇ to select a parameter item, the parameter with underline is current selected item.

Vibrator Parameter Modification

Short press Plus key $+$ /Minus key $-$ to modify the selected parameter item. Press and hold Plus key $+$ /Minus key $-$ to increase/decrease parameter value rapidly.

Vibrator Parameter Saving

Short press Confirm key \leftarrow to confirm and save current modified parameter. The blank area of the display will show "Save OK" to indicate saving successfully. Short press Back key \rightarrow to return to system parameter setting page.

3.3.7 Lock Panel Setting**Lock Panel Setting Introduction**

Lock Panel is to set the parameter of locking touch panel of the controller. When Lock Panel function is enabled, and the Lock Panel time elapsed, no any operation on the keys, the touch panel will be locked. When locked, the logic keys' function will be invalid until the touch panel is unlocked. When Lock panel function is disabled, the display will show screen protection with real time after 30 seconds.



Figure 29

Enter into Lock Panel Setting Page

Enter into System parameter setting page as shown in Figure 21 to Figure 23, short press Up key Δ /Down key ∇ to select "6.Lock Panel", short press Confirm key \leftarrow to enter into Lock Panel Setting page as shown in following Figure 29.

Lock Panel Parameter Items Introduction:

- Lock time is to modify the time to lock the panel, modification range is 0-3600S (Seconds).
- Enable is to enable or disable Lock Panel function, "YES" means the function enabled, "NO" means the function disabled.

Lock Panel Parameter Items Selection

Short press Up key Δ /Down key ∇ to select a parameter item, the parameter with underline is current selected item.

Lock Panel Parameter Modification

Short press Plus key $+$ /Minus key $-$ to modify the selected parameter item. Press and hold Plus key $+$ /Minus key $-$ to increase/decrease parameter value rapidly.

Lock Panel Parameter Saving

Short press Confirm key \leftarrow to confirm and save current modified parameter. The blank area of the display will show "Save OK" to indicate saving successfully. Short press Back key \rightarrow to return to system parameter setting page.

3.3.8 OFF Display Setting

OFF Display Setting Introduction

OFF Display is to set the parameter of the display going OFF. When OFF Display function is enabled, and OFF display time elapsed, no any operation on the keys, the display will go off. When Lock Panel function is enabled, OFF Display time is counted after the panel locked, when Lock Panel function is disabled, the display will show screen protection with real time after 30 seconds, then OFF Display time will be counted.



Figure 30

Enter into OFF Display Setting Page

Enter into System parameter setting page as shown in Figure 21 to Figure 23, short press Up key \triangle /Down key ∇ to select "7.OFF Display", short press Confirm key \leftarrow to enter into OFF Display Setting page as shown in following Figure 30.

OFF Display Parameter Items Introduction:

- OFF Time is to modify the time that the display goes off, modification range is 0-3600S (Seconds).
- Enable is to enable or disable the OFF Display function, "YES" means OFF Display function enabled, "NO" means the function disabled.

OFF Display Setting Parameter Selection

Short press Up key \triangle /Down key ∇ to select a parameter item, the parameter with underline is current selected item.

OFF Display Setting Parameter Modification

Short press Plus key $+$ /Minus key $-$ to modify the selected parameter item. Press and hold Plus key $+$ /Minus key $-$ to increase/decrease parameter value rapidly.

OFF Display Setting Parameter Saving

Short press Confirm key \leftarrow to confirm and save current modified parameter. The blank area of the display will show "Save OK" to indicate saving successfully. Short press Back key \rightarrow to return to system parameter setting page.

3.3.9 System Time Setting

System Time Setting Introduction

System Time is to set the parameter of system real time.



Figure 31

Enter into System Time Setting Page

Enter into System parameter setting page as shown in Figure 21 to Figure 23, short press Up key \triangle /Down key ∇ to select "8.System Time", short press Confirm key \leftarrow to enter into System Time Setting page as shown in following Figure 31 to Figure 33.

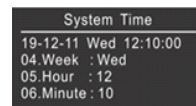

Figure 32

System Time Setting Parameter Items Introduction:

- System Time 1st line of the menus is current real time.
- The 01-07 items of the scroll down menus are the modified real time parameter.

System Time Parameter Items Selection

Short press Up key \triangle /Down key ∇ to select a parameter item, the parameter with underline is current selected item.

System Time Parameter Modification

Short press Plus key $+$ /Minus key $-$ to modify the selected parameter item. Press and hold Plus key $+$ /Minus key $-$ to increase/decrease parameter value rapidly.

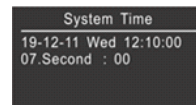

Figure 33

System Time Parameter Saving

Short press Confirm key \leftarrow to confirm and save current modified parameter. The blank area of the display will show "Save OK" to indicate saving successfully. Short press Back key \rightarrow to return to system parameter setting page.

3.3.10 Backlit Setting

Backlit Setting Introduction

Backlit is to set the parameter of the LED backlit brightness of the touch panel, modification range is 0%-100%.

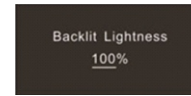

Figure 34

Enter into Backlit Setting Page

Enter into System parameter setting page as shown in Figure 21 to Figure 23, short press Up key \triangle /Down key ∇ to select "9.Backlit", short press Confirm key \leftarrow to enter into Backlit Setting page as shown in following Figure 34.

Backlit Parameter Modification

Short press Plus key $+$ /Minus key $-$ to modify the LED brightness. Press and hold Plus key $+$ /Minus key $-$ to increase/decrease brightness value rapidly.

Backlit Parameter Saving

Short press Confirm key \leftarrow to confirm and save current modified parameter. The blank area of the display will show "Save OK" to indicate saving successfully. Short press Back key \rightarrow to return to system parameter setting page.

3.3.11 Factory Reset Setting

Factory Reset Setting Introduction

Factory reset is to restore the master controller setting to factory defaults. Once factory reset, the controller's all parameters will be restored to the factory default values. It shall take a long time to reset, please be patient to wait.

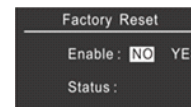

Figure 35

Enter into Factory Reset Setting Page

Enter into System parameter setting page as shown in Figure 21 to Figure 23, short press Up key \triangle /Down key ∇ to select "10.Factory Reset", short press Confirm key \leftarrow to enter into Factory Reset Setting page as shown in following Figure 35.

Factory Reset Parameter Items Introduction:

Enable is to enable or disable the Factory Reset function, "YES" means the function enabled, "NO" means the function disabled.

Factory Reset Parameter Modification

Short press Plus key $+$ /Minus key $-$ to modify the status of "Enable". "YES" means Factory reset function is enabled, "No" means the function is disabled.



Figure 36

Factory Reset Parameter Saving

Short press Confirm key \leftarrow to confirm and save the modified "Enable" status. The "Status" on the display will show real time factory reset status as shown in Figure 36 & Figure 37, The next line under "Status" shows the time needed for factory reset. Short press Back key \rightarrow to return to system parameter setting page.

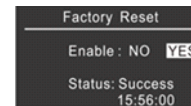
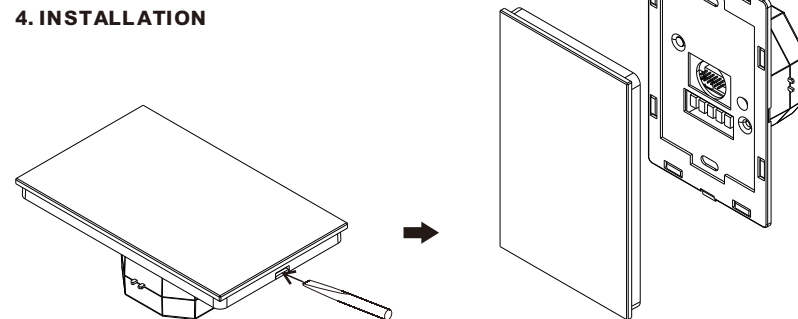
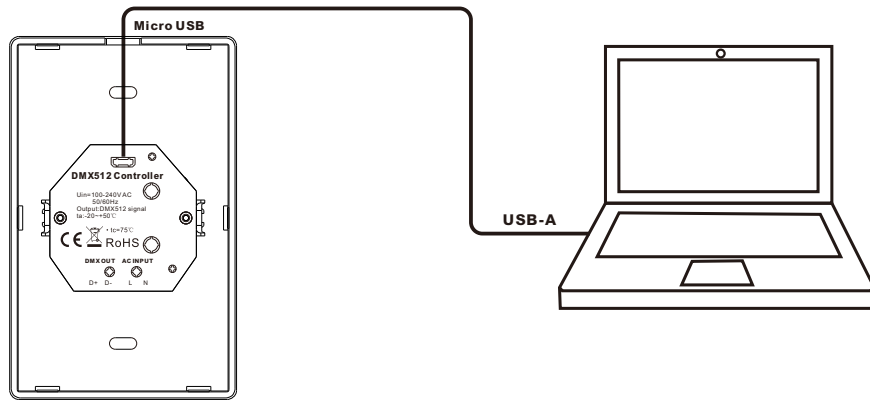

Figure 37

4. INSTALLATION



5. Master & PC Connection (If DMX PC software needs to be used)



Note:

- 1) please use an USB-A male to Micro USB male data cable to connect the master and the computer.
- 2) Please refer to the user manual of DMX Master PC software for detailed operations.