

# RF RGB & Dual Color Wall Mounted Controller

09.283Cl.04269



**Important:** Read All Instructions Prior to Installation

## Function introduction

Click or to choose the zone, Touch the sliders to dim CCT color (if choose CCT color zone) or RGB color(if choose RGB color zone)

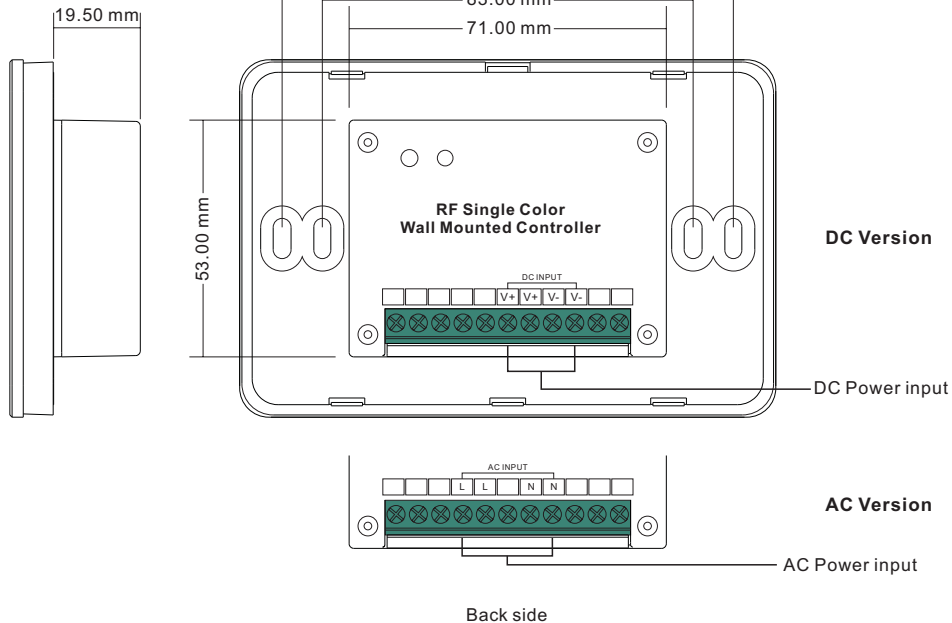
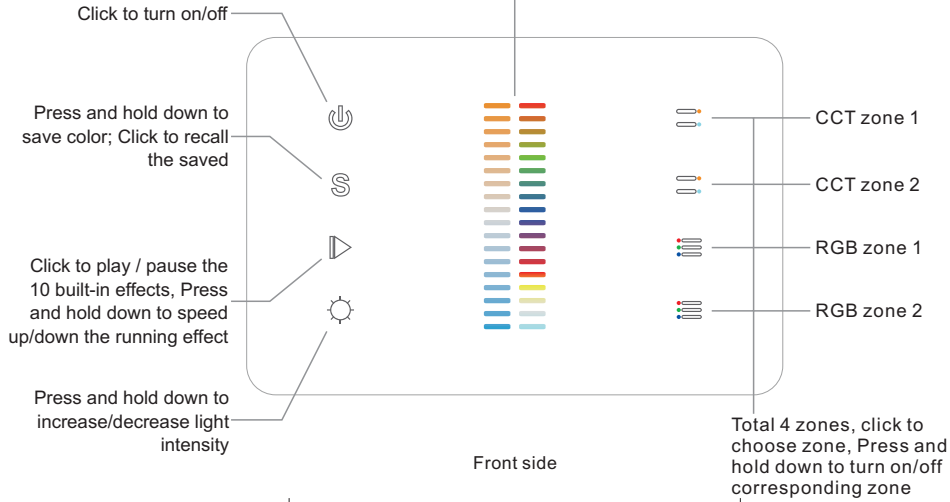

## Product Data

	DC Version	AC Version
Output Signal	RF signal	RF signal
Power Supply	12-24VDC	100-240VAC
Power consumption	200 mA	15 mA
Operating temperature	0-40°C	0-40°C
Relative humidity	8% to 80%	8% to 80%
Dimensions	120x80x29.1mm	120x80x29.1mm

- Touch sensitive
- Glass interface(white & black)
- Control RGB+CCT color
- Control 4 zones synchronously and separately
- Compatible with all universal series RF receivers, radio frequency: 869.5/434MHz
- Waterproof grade: Ip20

## Safety & Warnings

- DO NOT install with power applied to device.
- DO NOT expose the device to moisture.

## Wiring diagram

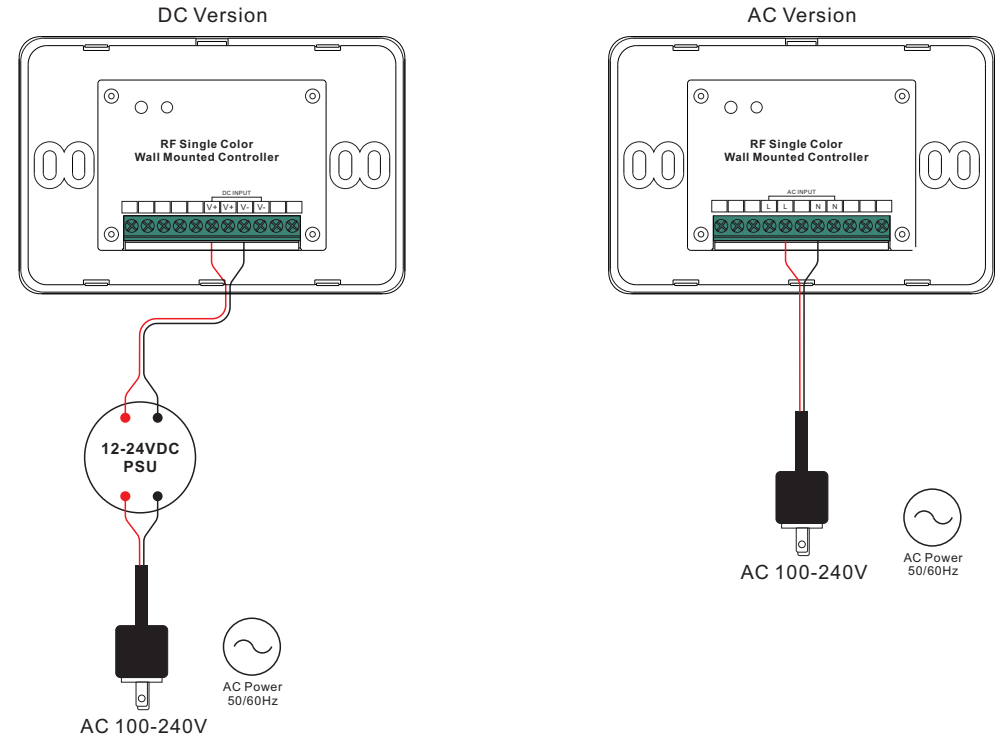



## Operation

1. Do wiring the wall panel & RF receiver according to wiring diagram (please refer to the instruction of RF receiver that you would like to pair with)
2. Power on, then touch the button  to turn on the controller, indicator of the controller turned blue

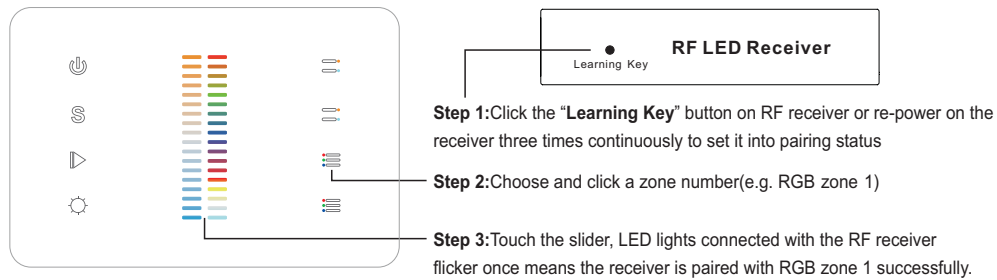
## Pair with RF receiver



**Note :**  only can pair with LED CCT color lighting.  only can pair with LED RGB color lighting.

## Operate the remote after pairing

Click the paired zone number/numbers, then touch the slider or the other buttons to do the controlling

## Built-in 10 color changing modes are as follows:

- Mode 1: Any two colors of RGB mix fade-in & fade-out
- Mode 2: RGB three colors mix fade-in & fade-out
- Mode 3: RGB three colors mix fade-out & fade-in
- Mode 4: RGB flash
- Mode 5: RGB three colors fade-in & fade-out successively
- Mode 6: RGB three colors fade-in successively
- Mode 7: RGB three colors fade-out successively
- Mode 8: RGB three colors jump changing successively
- Mode 9: R&B two colors mix fade (R in B out), then G fade-in, then R&B mix fade (R out B in), then G fade-out
- Mode 10: B fade-out, then G&B mix fade (G out B in), then R&G mix fade (R out G in), then R fade-in

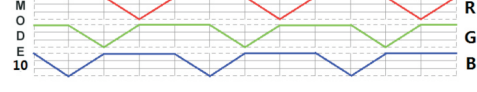
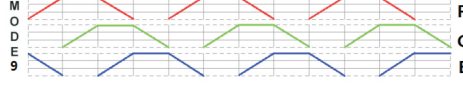
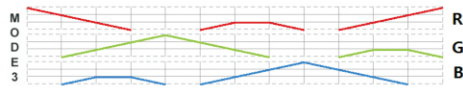
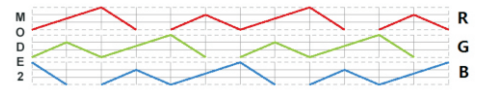
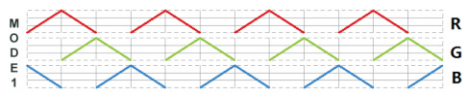

## Installation

