

RF Dual Color Wall Mounted Controller

09.280Bl.04184



Important: Read All Instructions Prior to Installation

Function introduction

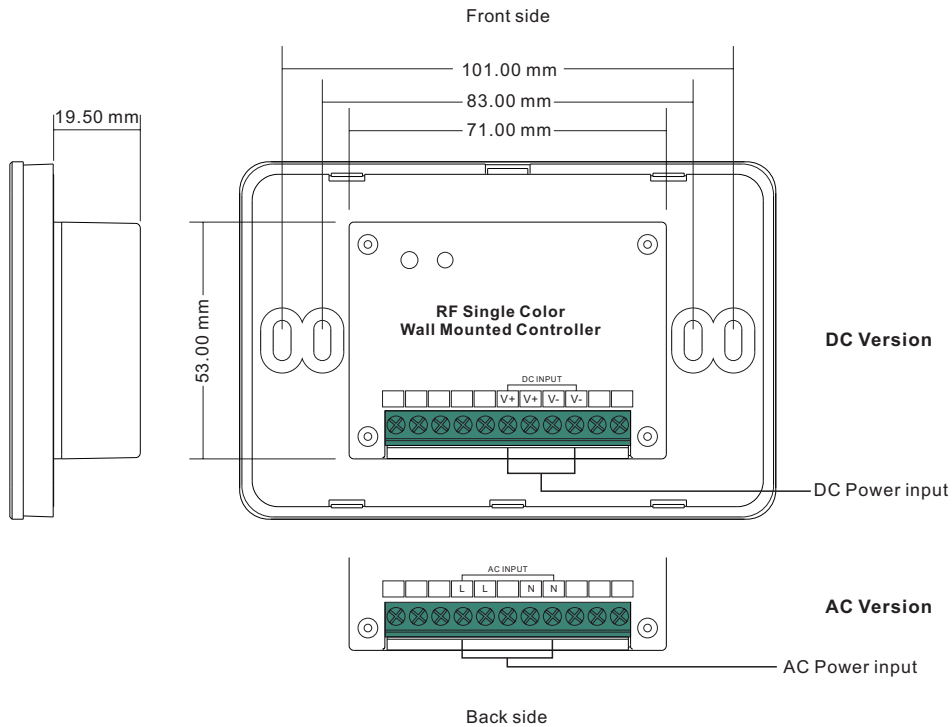
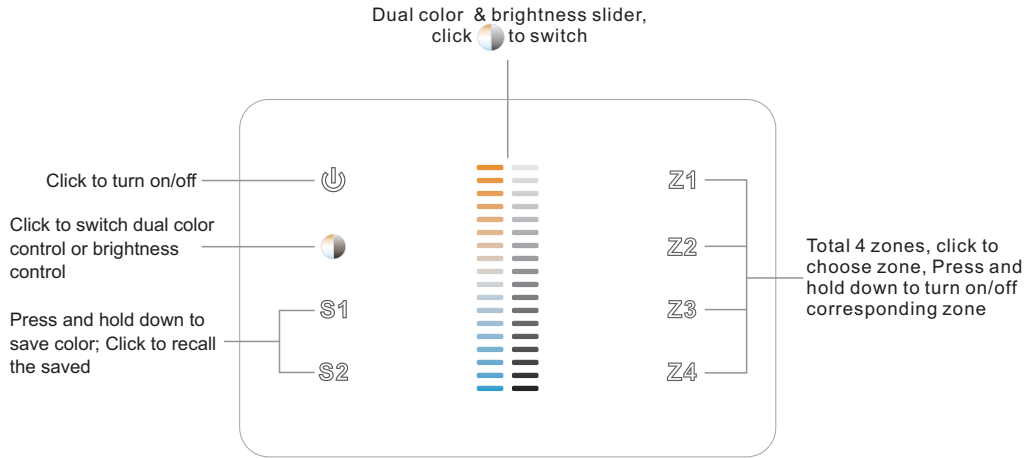

Product Data

	DC Version	AC Version
Output Signal	RF signal	RF signal
Power Supply	12-24VDC	100-240VAC
Power consumption	20 mA	20 mA
Operating temperature	0-40°C	0-40°C
Relative humidity	8% to 80%	8% to 80%
Dimensions	120x80x29.1mm	120x80x29.1mm

- Touch sensitive
- Glass interface(white & black)
- Control CCT color
- Control 4 zones synchronously and separately
- Compatible with all universal series RF receivers, radio frequency: 869.5/434MHz
- Waterproof grade: IP20

Safety & Warnings

- DO NOT install with power applied to device.
- DO NOT expose the device to moisture.

Wiring diagram

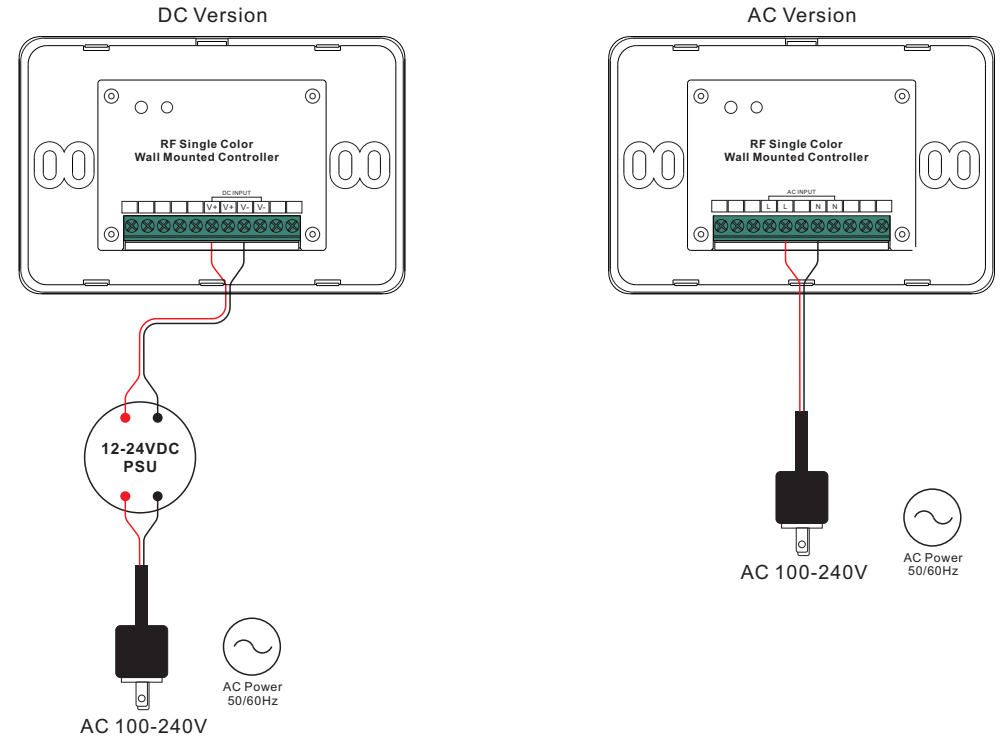

Operation

1. Do wiring the wall panel & RF receiver according to wiring diagram (please refer to the instruction of RF receiver that you would like to pair with)
2. Power on, then touch the button  to turn on the controller, indicator of the controller turned blue

Pair with RF receiver

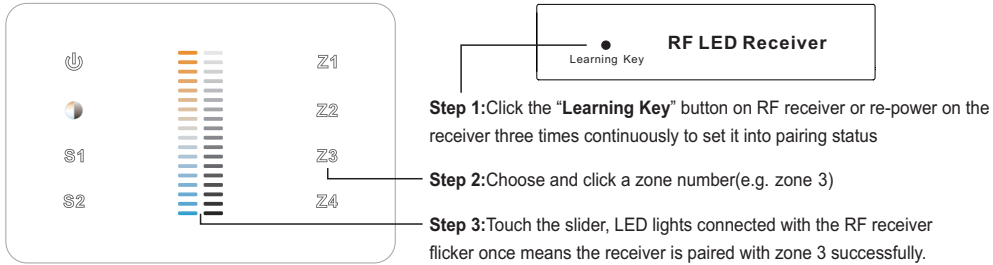

Save color/scene/mode

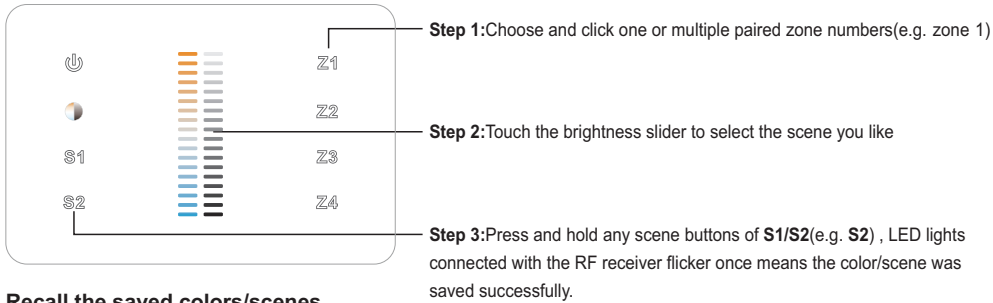

Recall the saved colors/scenes

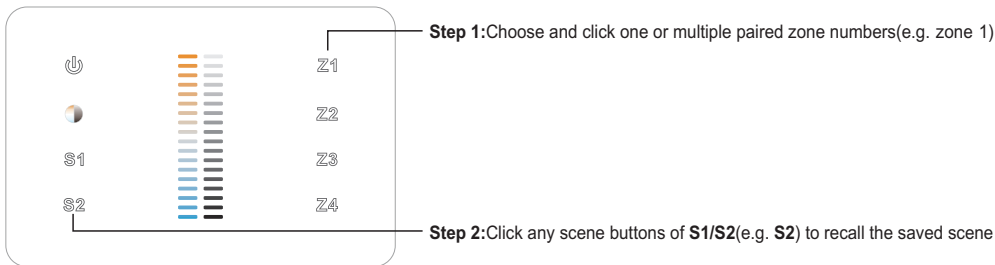

Installation

