

RF RGBW Wall Mounted Controller

09.282Bl.04267



Important: Read All Instructions Prior to Installation

Function introduction

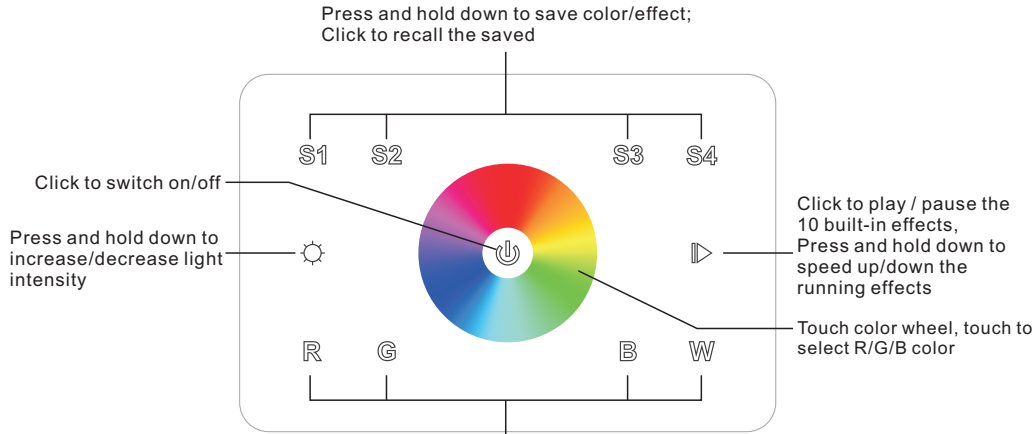

R/G/B/W 4channels: Click to turn off/on the channel
Press and hold down to increase/decrease light intensity of each channel

Front side

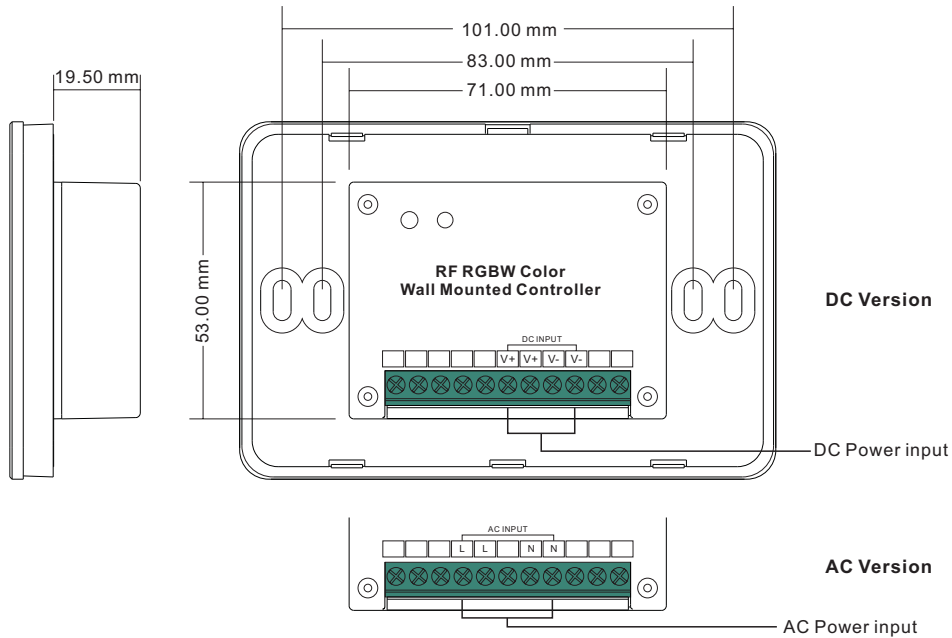

Back side

Product Data

	DC Version	AC Version
Output Signal	RF signal	RF signal
Power Supply	12-24VDC	100-240VAC
Power consumption	20 mA	20 mA
Operating temperature	0-40°C	0-40°C
Relative humidity	8% to 80%	8% to 80%
Dimensions	120x80x29.1mm	120x80x29.1mm

- Touch sensitive
- Glass interface(white & black)
- Control RGBW color
- Compatible with all universal series RF receivers
- Radio frequency: 869.5/434MHz
- Waterproof grade: IP20

Safety & Warnings

- DO NOT install with power applied to device.
- DO NOT expose the device to moisture.

Wiring diagram

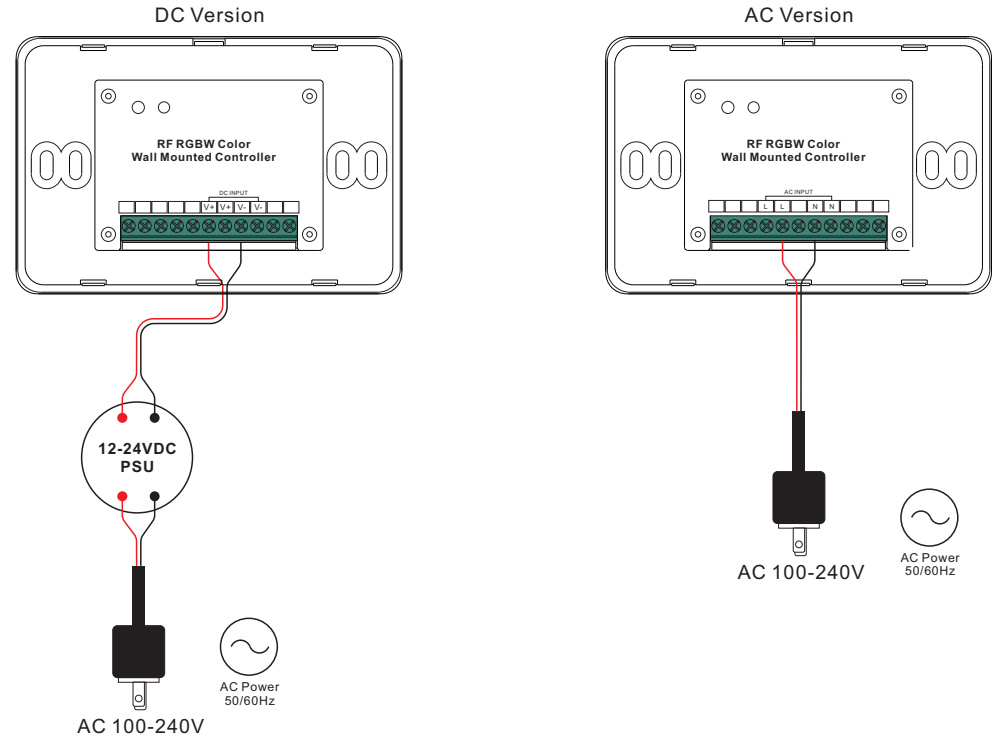

Operation

1. Do wiring the wall panel & RF receiver according to wiring diagram (please refer to the instruction of RF receiver that you would like to pair with)
2. Power on, then touch the button  to turn on the controller, indicator of the controller turned blue

Pair with RF receiver



Step 1: Click the "Learning Key" button on RF receiver or re-power on the receiver three times continuously to set it into pairing status

Step 2: Touch the color wheel, LED lights connected with the RF receiver flicker once means the receiver is paired with the wall panel successfully.

Built-in 10 color changing modes are as follows:

- Mode 1: Any two colors of RGB mix fade-in & fade-out
- Mode 2: RGB three colors mix fade-in & fade-out
- Mode 3: RGB three colors mix fade-out & fade-in
- Mode 4: RGB flash
- Mode 5: RGB three colors fade-in & fade-out successively
- Mode 6: RGB three colors fade-in successively
- Mode 7: RGB three colors fade-out successively
- Mode 8: RGB three colors jump changing successively
- Mode 9: R&B two colors mix fade (R in B out), then G fade-in, then R&B mix fade (R out B in), then G fade-out
- Mode 10: B fade-out, then G&B mix fade (G out B in), then R&G mix fade (R out G in), then R fade-in

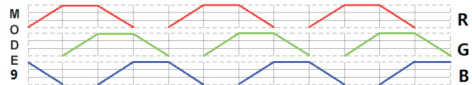
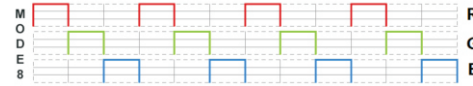
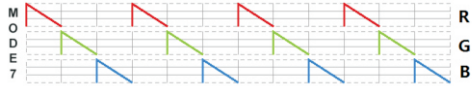
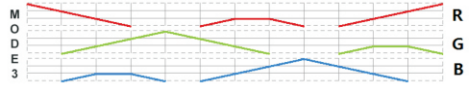
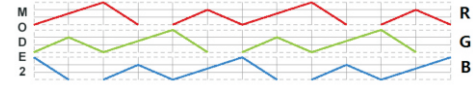

Installation

