

DIN Rail DALI Master Controller

70030140



Important: Read All Instructions Prior to Installation

Function introduction

Enable or disable built-in DALI PS by dip switches:

- ⬇ ⬇ Disable (dial both switches to "1 2" position)
- ⬆ ⬆ Enable (dial both switches to "ON" position)

Enable when use built-in DALI power supply
Disable when use external DALI power supply

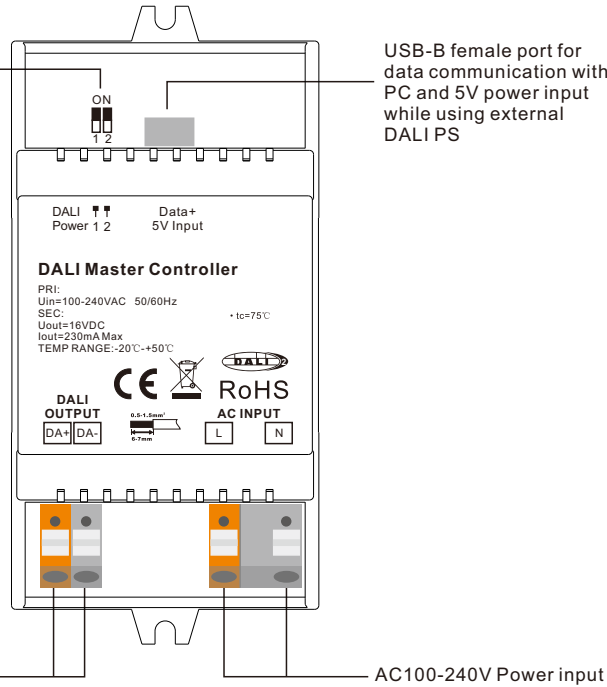

Product Data

While built-in DALI PS enabled

Input Voltage	Frequency	Number of DALI Channel	Output Voltage	Output Current	Size(LxWxH)	Ambient Temperature
100-240VAC	50/60Hz	1	16VDC	230mA max	110x53x65mm	-20°C ~ +50°C

While built-in DALI PS disabled

Input Voltage	Number of DALI Channel	DALI Current Consumption	Size(LxWxH)	Ambient Temperature
5VDC	1	4mA max	110x53x65mm	-20°C ~ +50°C

Safety & Warnings

- DO NOT install with power applied to device.
- DO NOT expose the device to moisture.

- Supports DT6, DT8 Tc, DT8 XY, DT8 RGBWA control gear device types, DALI-2 input devices
- Each DALI channel supports max 64 control gears, max 64 DALI-2 input devices
- Each DALI channel supports max 16 groups for control gears, 32 groups for input devices, 16 DALI scenes
- Built-in 230mA DALI PS, no extra wiring required
- Easy connect to a Windows PC through USB port

- Built-in battery, built-in RTC, supports timer task configuration
- Supports cycle schedule configuration
- Supports bionic schedule configuration (Human Centric Lighting)
- Waterproof grade: IP20

Wiring Diagram

1) While Use built-in DALI Power Supply

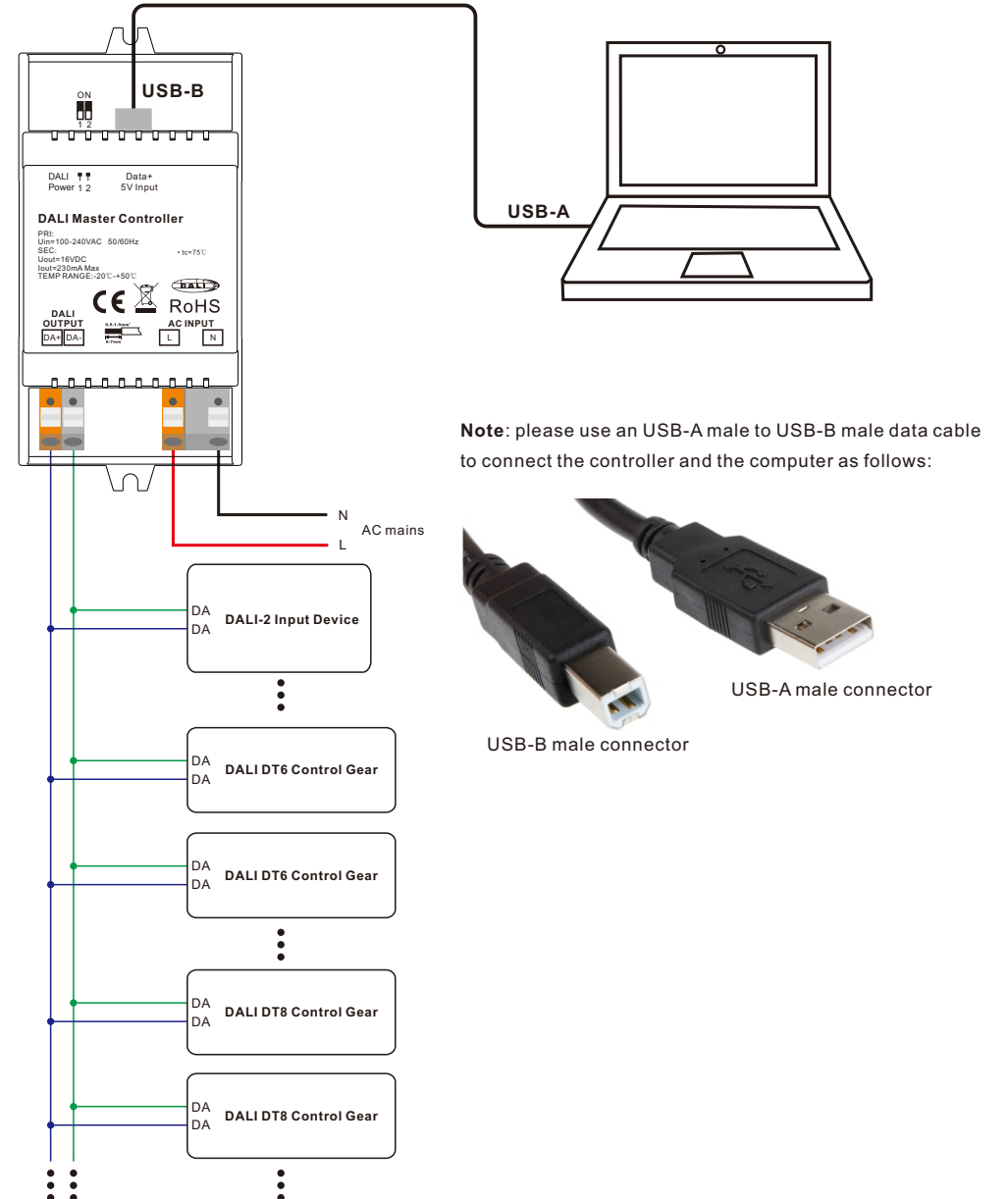

Note: When use built-in DALI power supply, please dial both DALI power setting dip switches to "ON" position. The controller can supports up to total 64 control gears and 64 DALI-2 input devices.

2) While Use External DALI Power Supply

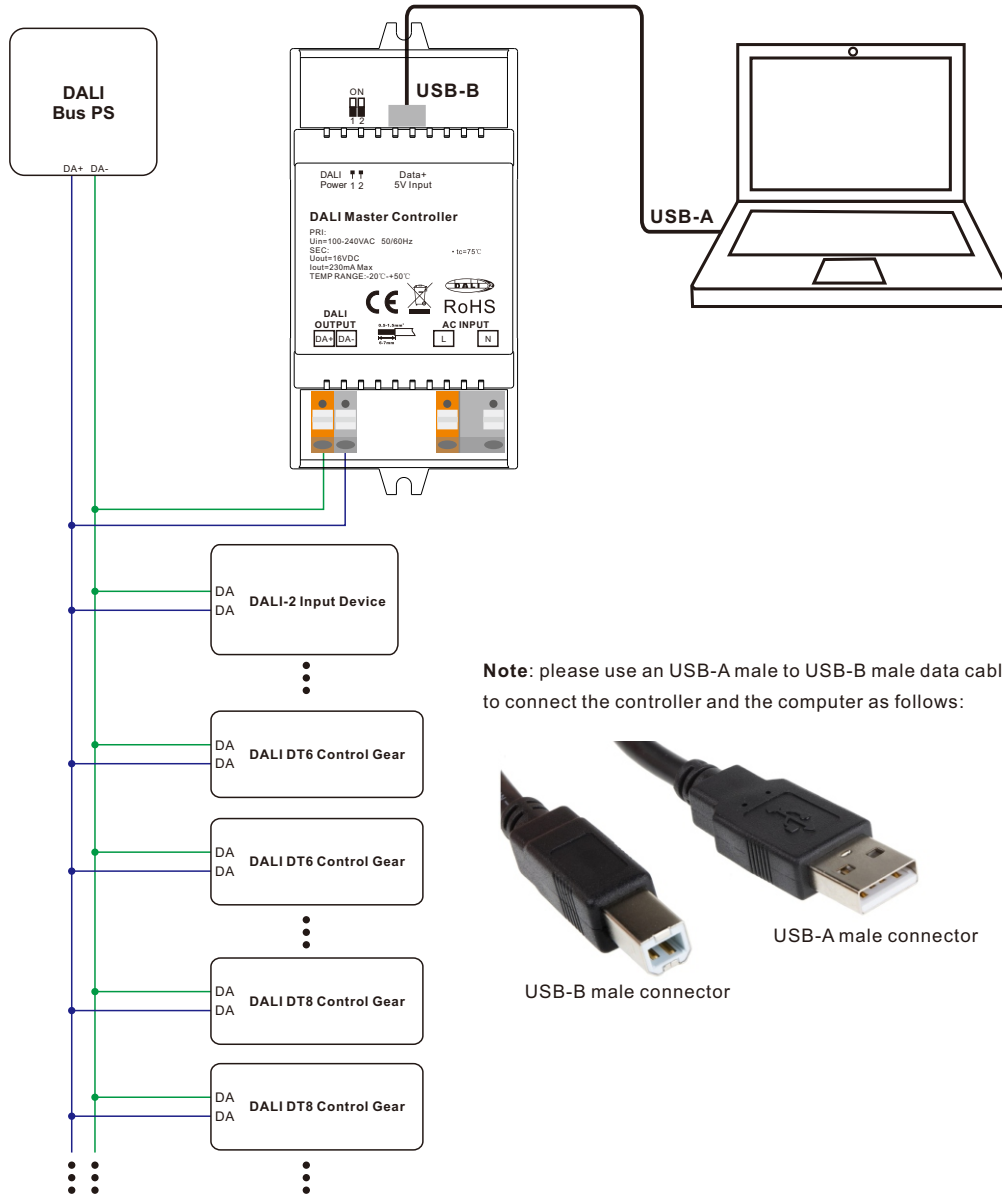

Note: please use an USB-A male to USB-B male data cable to connect the controller and the computer as follows:

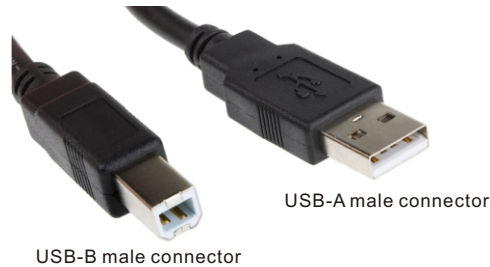

Note: When use external DALI power supply, please dial both DALI power setting dip switches to "1 2" position. the controller can support up to total 64 control gears and 64 DALI-2 input devices depending on external DALI PS.

Operation

1) Do wiring according to the wiring diagram and power on the DALI system.

2) Install the "DALI Master" software on the operating computer:

Step 1: Run the installation file and select installation mode as shown in **Figure 1**.

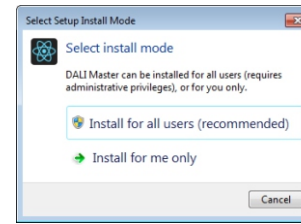

Figure 1 Select Installation Mode

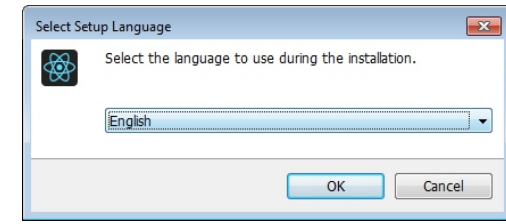

Figure 2 Select a Installation Language

Step 2: Select installation language as shown in **Figure 2**.

Step 3: Select installation path as shown in **Figure 3**.

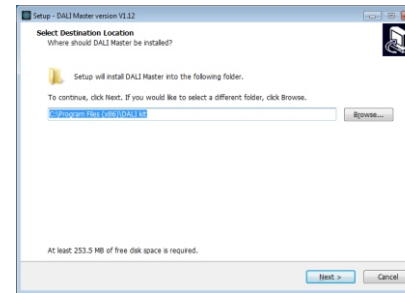

Figure 3 Installation Path

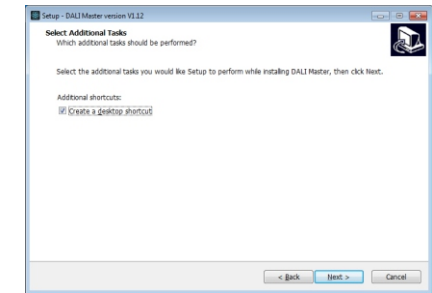

Figure 4 Create Desktop Shortcut

Step 4: Create desktop shortcut as shown in **Figure 4**.

Step 5: Starting installation as shown in **Figure 5**.

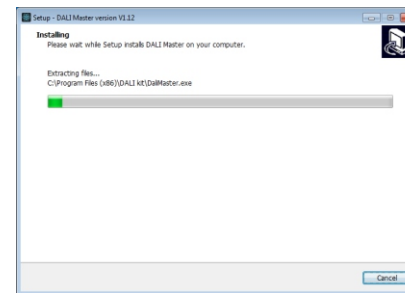

Figure 5 Starting Installation

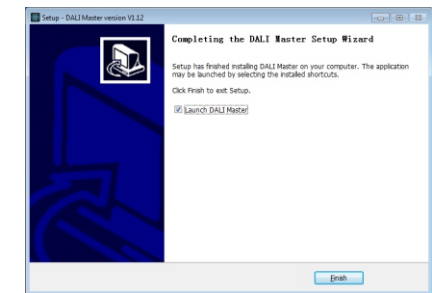

Figure 6 Complete Installation

Step 6: Complete installation as shown in **Figure 6**.

Notes:

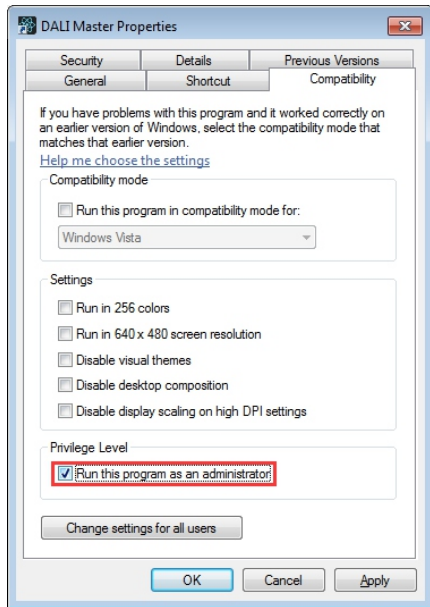

Figure 7 Run this program as an administrator

1) Please install the software according to the installation steps, otherwise it can not be started correctly.

2) This software is installed to disk C by default, if the installation path is not modified, please run the software as administrator, detailed method is as follows:

Step 1: Right click the desktop icon  to check the properties, switch to "Compatibility" tab, and check item "Run this program as an administrator" as shown in **Figure 7**.

Step 2: Click "OK" to complete the setting as shown in **Figure 7**.

3) If you need to re-install the software, if you need to change the installation path please first uninstall previous installation, otherwise just install to cover the previous installation.

Step 3: Right click "This PC", then click "Management", then click "Device Manager", then you can check whether the installation is successful or not as shown in **Figure 11**.

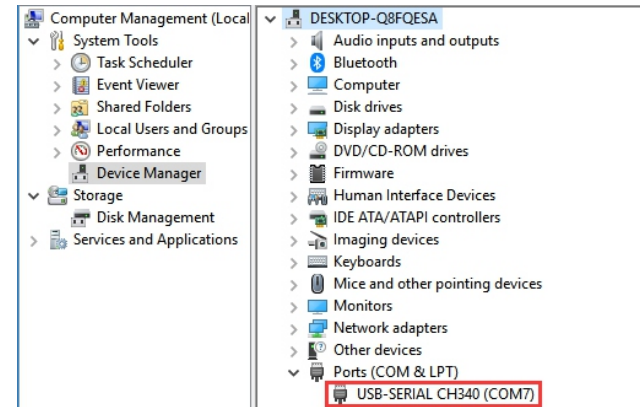

Figure 10 Driver Installation Successful

3) INSTALL CH340 DRIVER

Step 1: Connect the USB communication port wire, double click the file "CH341SER.EXE" to install, as shown in **Figure 8**.

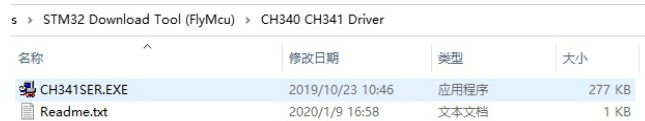

Figure 8 Double Click "CH341SER.EXE"

Step 2: If there is an indication that installation failed, please first uninstall the installation, then install again.

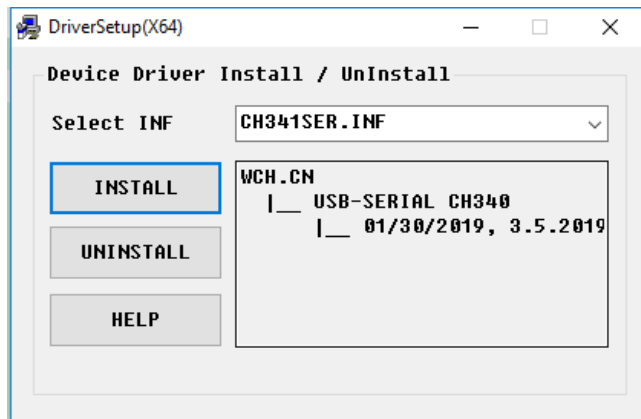

Figure 9 Driver Installation

5) Follow the instruction of the PC configuration software to configure the master controller and control gears, for detailed operation please refer to the user manual of the PC software.

Product Dimension

